

# Implications of the Application of Recursive Least Squares Algorithms to Satellite Orbit Determination Using GPS Measurements

PAULA CRISTIANE PINTO MESQUITA PARDAL<sup>1</sup>, HELIO KOITI KUGA<sup>1</sup>, RODOLPHO VILHENA DE MORAES<sup>2</sup>

<sup>1</sup> DMC (Space Mechanics and Control Division)  
INPE (Brazilian Space Research Institute)

Av dos Astronautas, 1.758. Jd. Granja - CEP: 12227-010. São José dos Campos - SP  
BRAZIL

<sup>2</sup> Department of Mathematics

FEG - UNESP (São Paulo State University)

Av Dr Ariberto Pereira da Cunha, 333 - CEP: 12.516-410. Guaratinguetá - SP  
BRAZIL

paula@dem.inpe.br, hkk@dem.inpe.br, rodolpho@feg.unesp.br

*Abstract:* The main target here is to determine the orbit of an artificial satellite and to analyze its implications, using least squares algorithms through sequential Givens rotations as the method of estimation, and data of the GPS receivers. This approach longs for to improve the performance of the orbit estimation process and, at the same time, to minimize the computational procedure cost. Perturbations due to high order geopotential and direct solar radiation pressure were taken into account. The position of the GPS antenna on the satellite body that, lately, consists of the influence of the satellite attitude motion in the orbit determination process, was also considered. An application has been done, using real data from the Topex/Poseidon satellite, whose ephemeris were available. In a process of high accuracy orbit determination, frequently a sinusoidal residual behavior is observed during its error analysis. Actually, it is the result of unmodeled residual accelerations, which present frequencies near or multiple to the satellite period and appear by different reasons. Assuming that we cope with the unmodeled accelerations, which have no direct physical reasons, or that the modeling effort is not worthwhile, such accelerations will also be analyzed, empirically.

*Key-Words:* Estimation, GPS Measurements, Least Squares Algorithms, Orbit Perturbation, Satellite Orbit Determination, and Unmodeled Accelerations.

## 1 Introduction

The problem of orbit determination consists essentially of estimating parameters values that completely specify the body trajectory in the space, processing a set of measurements from this body. Such observations can be collected through a tracking network on Earth or through sensors, like the GPS receiver onboard Topex/Poseidon (T/P).

The Global Positioning System (GPS) is a powerful and low cost means to allow computation of orbits for artificial Earth satellites. The T/P satellite is an example of using this system for space positioning.

The orbit determination of artificial satellites is a nonlinear problem in which the disturbing forces are not easily modeled, like geopotential and direct solar radiation pressure. Throughout an onboard GPS receiver is possible to obtain measurements (pseudoranges) that can be used to estimate the state of the orbit.

Usually, the iterative improvement of the position parameters of a satellite is carried out using the least squares methods. On a simple way, the least squares estimation algorithms are based on the data equations that describe the linear relation between the residual measurements and the estimation parameters.

## 2 The Global Positioning System (GPS)

The Global Positioning System (GPS) is a U.S.A. space-based radio navigation system that provides reliable positioning, navigation, and timing services. While there are many thousands of civil users of GPS world-wide, the system was designed for and is operated by the U. S. military. For anyone with a GPS receiver, the system will provide location and time. GPS provides accurate location and time

information for an unlimited number of people in all weather, day and night, anywhere in the world.

The GPS is formed by three segments: satellites orbiting the Earth (space segment); control and monitoring stations on Earth (control segment); and the GPS receivers owned by users (user segment) [1]. GPS satellites broadcast signals from space that are picked up and identified by GPS receivers. Each GPS receiver then provides three-dimensional location (latitude, longitude, and altitude) plus the time. Fig. 1 shows a scheme for the space segment

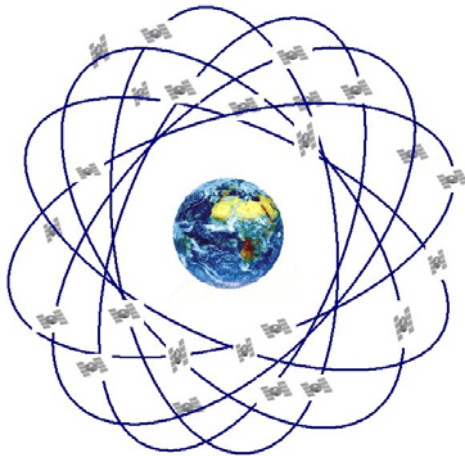

Fig. 1 - Satellites orbiting the Earth in the GPS space segment.

Equipped with these GPS receivers, users can accurately locate where they are and easily navigate to wherever they want to go, whether walking, driving, flying, or boating [2]. GPS has become a mainstay of transportation systems worldwide, providing navigation for aviation, ground, and maritime operations. Disaster relief and emergency services depend upon GPS for location and timing capabilities in their missions.

### 3 Orbit Determination via GPS

The basic principle of GPS working method is based on the geometric method, in which the observer knows the position of a set of satellites in a so called inertial reference frame, and your position with regard to this set, obtaining your own position in the reference system. Fig. 2 presents the main parameters used by GPS on a user positioning [3].

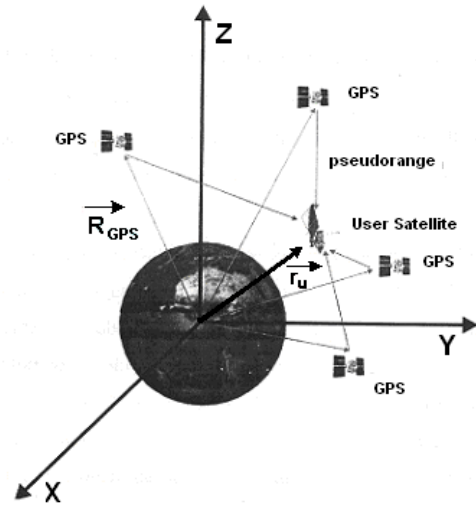

Fig. 2 - Geometric Method for GPS positioning.

where  $\vec{r}_u$  is the satellite user (which carries a GPS receiver) position vector, and  $\vec{R}_{GPS_i}$  is the position of the  $i$ -th GPS satellite.

Assuming that there is a perfect synchronization among the clocks, and neglecting the ionospheric distortion effects, relativistic effects, and all other effects, the geometric distance could be defined as the time that GPS signal takes to go out the GPS satellite and arrives at the user receiver. Although, it is necessary to admit that the synchronization deviations among the user and the satellites clocks exist. Taken into account the ionospheric deviations, and neglecting all the others effects, the pseudorange can be defined.

$$\rho_i = P_i - b_u + D_{ION} \tag{1}$$

where  $P_i$  is the pseudorange from user to  $i$ -th GPS satellite;  $b_u$  is the error corresponding to the user's clock deviation, and  $D_{ION}$  is due to the ionospheric delay.

That is the reason for the need of, at least, four satellites being watched at the same time: in order to obtain a system of four equation and to be able to determine the position coordinates (x, y, z), and  $b_u$ . It is important to emphasize that, depending on the relative geometry of the satellites, the equation system can or cannot have a solution. Besides, if more than four satellites were watched simultaneously, there will be a subset that will provide the solution with the minor error.

## 4 Recursive Least Squares Using Sequential Givens Rotations

Parameters estimation aims at estimating things that are constant along the estimation process. It is necessary a set of measurements to mathematically shape the relationship between these measurements and the parameters or state to be estimated.

One of the most used parameter estimator is the least squares algorithm. Basically, the algorithm minimizes the cost function of the residuals squared [4]. The recursive least squares algorithms, when applied to parameters or state estimation, presents two advantages: avoids matrix inversion in the presence of uncorrelated measurement errors; and needs smaller matrices sizes, which means less need of memory storage.

### 4.1 Kalman Form

In the Kalman form, the equations are given by [5]:

$$\text{Estimated state: } \Delta \hat{x}_i = \Delta \hat{x}_{i-1} + K_i (\Delta y_i - H_i \Delta \hat{x}_{i-1})$$

$$\text{Error covariance matrix: } \hat{P}_i = (I - K_i H_i) P_{i-1} \quad (2)$$

$$\text{Kalman gain: } K_i = P_{i-1} H_i^T [H_i P_{i-1} H_i^T + R_i]^{-1}$$

where  $P$  is the error in state covariance matrix;  $\hat{x}$  is the estimated state vector; and the measurements are modeled by the non linear relation  $y = h(x) + v$ , which gives, after linearization:

$$\Delta y = H \Delta x + v$$

$$\Delta y = y - \hat{y}, \quad \Delta x = x - \bar{x}, \quad H = \frac{\partial h}{\partial x} \quad (3)$$

### 4.2 Recursive Least Squares Using Sequential Givens Rotations

The Givens rotations are used when it is fundamental to cancel specific elements of a matrix. Alternative formulations were developed, based on the QR factorization methods, to solve this deficiency. Using orthogonal transformations, the equation matrix of data can be transformed on a triangular higher form, to which the least squares solution is obtained by a simple substitution. The aim of applying orthogonal transformations in matrices and vectors on the least squares problem is to substitute the matrices inversion by a stronger method, with less numerical errors. The Givens

rotations [5] are a method to solve recursive least squares through orthogonal transformations [6].

The Givens rotations are used when is essential to annul specific elements of a matrix. In this procedure, a given matrix becomes triangular by a series of orthogonal matrices. The full transformation generically can be given by:

$$\begin{pmatrix} R \\ 0 \end{pmatrix} = (U_m \ U_{m-1} \ \dots \ U_3 \ U_2) H = Q^T H \quad (4)$$

$$\begin{pmatrix} d \\ r \end{pmatrix} = (U_m \ U_{m-1} \ \dots \ U_3 \ U_2) y = Q^T y$$

where  $R$  is an upper triangular matrix triangular. At each step, the orthogonalization of the  $H$  matrix is performed (producing a transformed measurement vector  $d$  and  $r$ ), and the results are stored to the next set of measurements [8, 7].

The matrices orthogonal transformation has remarkable character in the numeric calculation of least squares problems. The reasons are due to keep invariant the vector euclidean length and due to solve numerically and with robustness the problem

## 5 Disturbing Effects Considered

The solar radiation pressure is a force of non gravitational origin that disturbs the translational motion of an artificial satellite. Solar radiation pressure is engendered throughout a continuous flux of photons that stumble at satellite surfaces, which can absorb or reflect such flux. The rate which all incident photons reach the satellite surfaces origins the solar radiation pressure force, what can cause perturbations on the orbital elements.

The components of solar radiation pressure force can be expressed in several systems. Throughout these systems, the orbital elements of the satellite can be connected with sun's position. This procedure was used for the direct solar radiation pressure model adopted for the T/P satellite [10].

### 5.1 Perturbations due to Geopotential

Earth gravitational field and its associated attraction force are studied in the case of an artificial satellite. The geopotential is a force of gravitational origin that disturbs the orbits of artificial Earth satellites. Earth gravitational field represents one of the main perturbations on the motion of artificial satellites. The principal term due to Earth oblateness is  $J_2$ , and the others terms are considered according to the mission accuracy.

The potential function is given by [4]:

$$U(r, \phi, \lambda) = \frac{\mu}{r} \sum_{n=0}^{\infty} \sum_{m=0}^n \left(\frac{R_T}{r}\right)^n P_{nm}(\sin \phi) \times (C_{nm} \cos m\lambda + S_{nm} \sin m\lambda) \quad (5)$$

where  $\mu$  is Earth gravitational constant;  $R_T$  is Earth radius;  $r$  is the spacecraft radial distance;  $\phi$  is the geocentric latitude;  $\lambda$  is the longitude on Earth fixed coordinates system;  $C_{nm}$  and  $S_{nm}$  are the normalized harmonic spherical coefficients, with  $n$  degree and  $m$  order;  $P_{nm}$  are the normalized Legendre associated functions, with  $n$  degree and  $m$  order.

### 5.2 Perturbations due to Direct Solar Radiation Pressure

The solar radiation pressure is a force of non gravitational origin that disturbs the translational motion of an artificial satellite. Solar radiation pressure is engendered throughout a continuous flux of photons that stumble at satellite surfaces, which can absorb or reflect such flux. The rate which all incident photons reach the satellite surfaces origins the solar radiation pressure force, what can cause perturbations on the orbital elements.

The components of solar radiation pressure force can be expressed in several systems. Throughout these systems, the orbital elements of the satellite can be connected with sun's position. This procedure was used for the direct solar radiation pressure model adopted for the T/P satellite [10].

#### 5.2.1 Direct Solar Radiation Pressure Model for the TOPEX/POSEIDON Satellite

The force model describes the motion of a satellite's center of mass, but the range measurements are seldom considered at this point. In the case of T/P, they are taken from the location of the center of the antenna. For this reason, it is important the knowledge about satellite attitude motion. Fig.3 shows Topex's antenna in relation to rest of the spacecraft [10], and Table 1 gives the antenna offsets with respect to the center of mass [11].

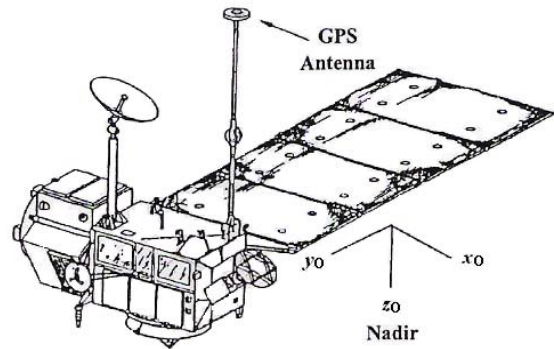

Fig. 3 - Topex GPS antenna location.

where  $(x_0, y_0, z_0)$  is the orbit fixed coordinates system, with its origin in the satellite's center of mass.

In estimating the Topex state there is a complex, predetermined attitude model being applied. This model was created to maneuver the solar array towards the sun for the most sun-facing surface area while still pointing the altimeter in the nadir direction [12]. In basic terms, this model gives rotation angles about the orbit local coordinates to allow for positioning of the antenna with respect to the center of mass. In truth, the recursive least squares algorithm returns position and velocity coordinates in relation to antenna location. Since the update is only a coordinate translation, it is instead applied to the center of mass.

Table 1 - Attitude information in Topex case study.

Antenna X coordinate	2.104949 m
Antenna Y coordinate	-0.45854 m
Antenna Z coordinate	-4.53263 m
Roll bias	-0.015 deg
Pitch Bias	-0.15 deg

For completeness, it needs to be stated that the attitude model also gives the orientation of the solar array. This orientation, along with the spacecraft position and the sun's position are used to compute the direct solar radiation pressure.

### 5.2.2 Model Development

Topex spacecraft was launched on an Ariane rocket on August 10, 1992 and had ceased operations on January 5, 2006. It was a dedicated altimetry mission to precisely measure the ocean topography. The spacecraft was in a circular “frozen” orbit at an altitude of 1336 km and an inclination of 66 deg, resulting in a ground track that repeats every 10 days.

The common method for computing the radiation pressure upon orbiting satellites within the orbit determination software had been to ignore rotating, attitude controlled, geometrically complex shapes and to treat the satellite form as a symmetrically perfect and rotationally invariant sphere, or so-called cannonball. The approaches of the cannonball radiation pressure model were not adequate to meet the required 6-cm rms error budget for modeling the radiation forces acting on T/P over a 10-day period. After considerable analysis of all surface force contributions, resultant models to be used in Topex orbit determination were presented [10].

The first step in a detail analysis of the radiation forces acting on Topex was to accurately compute all the radiation forces upon T/P with the use of a finite element model of the spacecraft. Since a precise thermal and radiative model of a satellite is necessarily computationally intensive, this micromodel, which served as a “truth” model, was computed offline. A relatively simple and less computationally intensive model, called macromodel, more suitable for precise orbit computations, was devised and tested to emulate the micromodel. One representation of this development is shown in Fig. 4.

This concept is based on approximating the satellite shape with a combination of flat plates. For Topex, a box-wing shape was chosen, with the plates aligned along the satellite body-fixed coordinate system ( $x_B$ ,  $y_B$ ,  $z_B$ ).

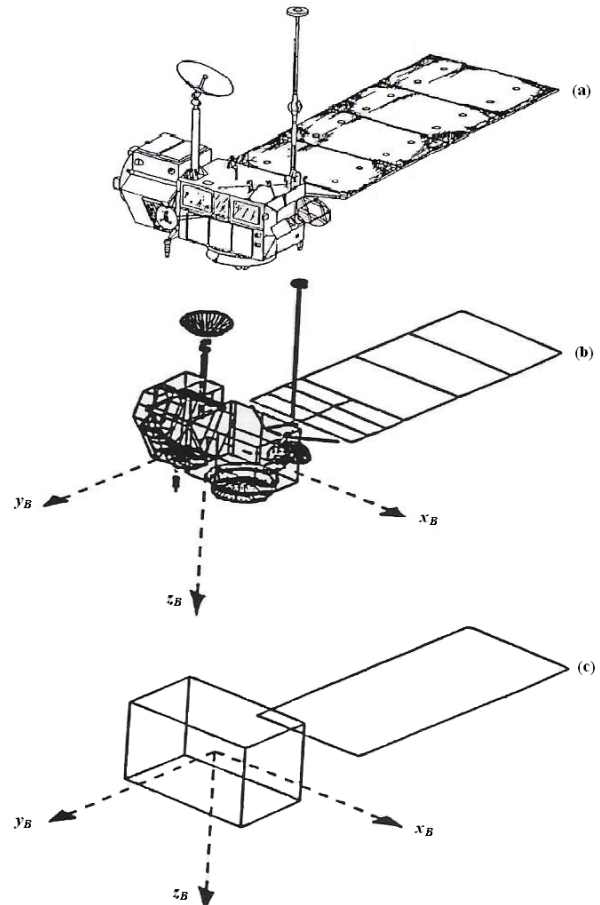

Fig. 4 - The Topex/Poseidon spacecraft is shown in (a); the corresponding micromodel in (b); and the corresponding macromodel in (c).

### 5.2.3 Radiant Energy of the Sun

The major source of radiant energy which T/P will encounter is the sun. The sun emits a nearly constant amount of photons per unit of time, varying less than 0.2%, that acts on the surfaces of artificial satellites. The force produced by this radiation is by far the largest of the radiative effects [7]. Also, for Topex, it is the largest nongravitational force acting on the satellite. This is the reason for considering only this parcel of the radiation forces herein.

The model of force acting on each plate is given by [5]:

$$\vec{F} = \frac{GA \cos \theta}{c} \left[ 2 \left( \frac{\delta}{3} + \rho \cos \theta \right) \hat{n} + (1 - \rho) \hat{s} \right] \quad (6)$$

where  $G$  is solar radiant flux ( $\text{W}/\text{m}^2$ );  $A$  is the surface area of each plate ( $\text{m}^2$ );  $\delta$  is difusive reflectivity, percentage of the total incoming radiation;  $\rho$  is specular reflectivity, percentage of the total incoming radiation;  $\hat{n}$  is surface normal vector;  $\hat{s}$  is source incidence vector;  $\theta$  is the angle between

surface normal and solar incidence; and  $c$  is the speed of light (m/s).

There are 8 plates in the model developed for Topex, according to the box-wing shape chosen. So, it is necessary to compute independently the direct solar radiation force acting on each surface. All plate interaction effects, such as shadowing, reflection, and conduction are ignored. This yields vector forces which are summed to compute the total effect on the spacecraft's center of mass. Mathematically, Eq. (7) shows it, and Tables 2 and 3 gives specific information about each of the surfaces, which are necessary to compute the total effect of direct solar radiation force on T/P.

$$\vec{F}_k = \frac{GA_k \cos \theta_k}{c} \left[ 2 \left( \frac{\delta_k}{3} + \rho \cos \theta_k \right) \hat{n}_k + (1 - \rho_k) \hat{s} \right] \quad (7)$$

$$\Rightarrow \vec{F} = \sum_{k=1}^8 \vec{F}_k$$

where subscript  $k$  varies from 1 to 8, representing each plate, and  $\vec{F}$  is the total direct solar radiation force acting on the satellite.

Table 2 - Macromodel plate normal vectors in the satellite body-fixed system.

	X+	X-	Y+	Y-	Z+	Z-	SA+	SA-
Area [m <sup>2</sup> ]	3.74	3.77	8.27	8.07	8.67	8.44	21.4	21.44
Specular ref.	0.201	0.244	0.886	0.782	0.239	0.275	0.05	0.17
Diffuse ref.	0.375	0.386	0.302	0.339	0.390	0.363	0.22	0.66
Emissivity	0.769	0.995	0.876	0.714	0.770	0.746	0.87	0.88

Table 3 - Plates characteristics for direct solar radiation pressure model.

Plate	$x_B$	$y_B$	$z_B$
X+	1.0	0.0	0.0
X-	-1.0	0.0	0.0
Y+	0.0	1.0	0.0
Y-	0.0	-1.0	0.0
Z+	0.0	0.0	1.0
Z-	0.0	0.0	-1.0
SA+	1.0	0.0	0.0
SA-	-1.0	0.0	0.0

## 6 Unmodeled Accelerations

Some spacecraft missions require precise orbit knowledge to support payload experiments. Sometimes after launch, ground based orbit determination solutions do not provide the level of accuracy expected. After verifying all known dynamic models, there may be a residual signature

in the orbit as result of unmodeled accelerations. This leads to attempt to estimate anomalous accelerations during the orbit fit, if sufficient data exist. If successful, the acceleration estimates can improve the fit residuals, and also results in better orbital position estimates [13].

Unmodeled accelerations may have many reasons: truncation of geopotential field; limitations of modeling solar pressure, Earth albedo, Earth infrared radiation, drag; and others. Some of these accelerations can be corrected through the use of higher fidelity dynamic and physical modeling, while others require post-launch calibration.

The use of periodic accelerations, with a period near once per revolution of the satellite orbit, has been used within precision orbit determination programs to improve the accuracy of the derived ephemeris.

### 6.1 Modeling Anomalous Accelerations

When defining an anomalistic or periodic acceleration, one must consider three aspects: the subarc interval, the type of function, and the coordinate frame.

#### 6.1.1 Subarc Interval

The subarc interval is the time of duration or number of revolutions for a given acceleration to be active. As its name implies, it is usually a subset of the total arc. A reason to break an arc into a subarc is to allow for better overall fits.

#### 6.1.2 Type of Function

The underlying mathematical function of an acceleration function is usually a constant, a sine or a cosine function.

The constant function is the most basic: a constant force in a specific direction. And the periodic functions (sine or cosine) have amplitude, frequency, and phase associated with them. The periodic functions are written as [13]:

$$accel = A \sin(\omega t + \phi_A)$$

or

$$accel = B \cos(\omega t + \phi_B) \quad (8)$$

where  $A$  and  $B$  are amplitudes;  $\omega$  is the frequency;  $t$  is the time elapsed since the start of the periodic function reference point or subarc interval; and,  $\phi_A$  and  $\phi_B$  are the phase offsets. Either of these accelerations can be rewritten as:

$$accel = A' \sin(\omega t) + B' \cos(\omega t) \quad (9)$$

where for a sine acceleration the phase are  $A' = +A \cos \phi_A$ ;  $B' = +A \sin \phi_A$ , and, for a cosine, they are  $A' = -B \cos \phi_B$ ;  $B' = +B \sin \phi_B$ . When estimated, the amplitudes  $A'$  and  $B'$  will adjust themselves to produce an effective phase offset.

### 6.1.3 Coordinate Frame

The selection of the start of the subarc can be important, especially for non-circular orbits. Conventionally, equator crossings, argument of perigee, mean anomaly or orbit angle have been used as reference point.

## 7 Results

Here, the tests and analysis from the algorithm developed to compute direct solar radiation pressure are presented. On the analysis of direct solar radiation pressure is already included Topex's GPS antenna location that, lately, consists of the influence of the satellite attitude motion in the orbit determination process. The algorithm was implemented through FORTRAN language [14, 15, 16].

To validate and to analyze the proposed method, real data from the T/P satellite were used. Position and velocity to be estimated were compared with Topex's precise orbit ephemeris (POE), from JPL/NASA. The test conditions considered pseudo-range real data, collected by GPS receiver onboard Topex, on November 18, 1993. The tests occurred at the same day, for a short period (2 hours) and a long period (24 hours) of orbit determination.

The tests conditions for obtaining the results herein showed, are summarized in Table 4.

Table 4 - Test conditions.

Numeric integrator	7 <sup>th</sup> order Runge-Kutta
Numeric integrator step, [s]	10
Forces Model	Geopotential - JGM-2 (50x50) Specific direct solar radiation pressure model for the Topex
Ionospheric correction	YES
Determination periods, [s]	7200, 86400
Selective Availability	OFF
Rejection of measurements control, [m]	Greater than 3000
State Estimator	Recursive Least Squares Methods

In a first step, it was analyzed the effect of including the considered perturbations in orbit propagation, before orbit determination through

least squares estimation. Fig. 5 and Fig. 6 show the behavior of the error, in meters, in RNT (radial, normal, and transverse) system, along a 24 hours period, which is a meaningful interval of time in case of orbit propagation.

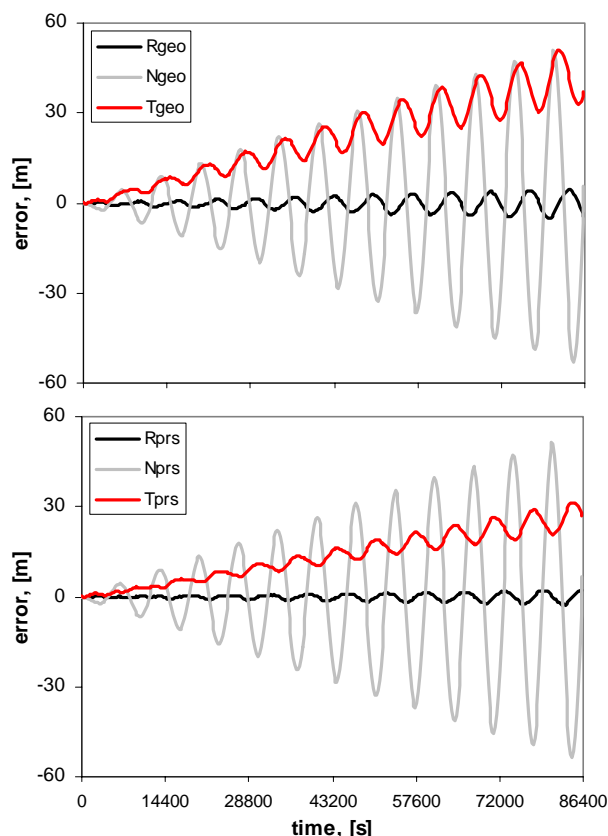

Fig.5 - Orbit propagation per 24 hours period for 11/18/93.

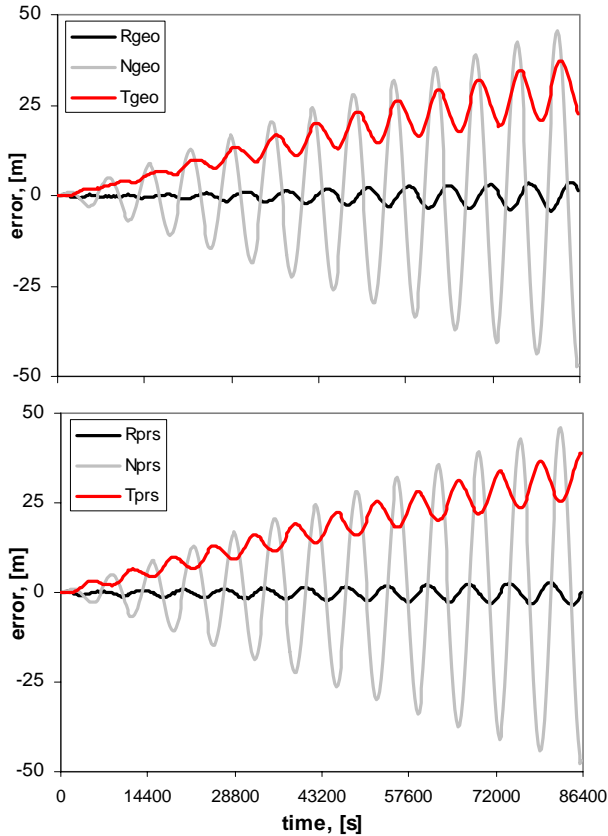

Fig.6 - Orbit propagation per 24 hours period for 11/19/93.

The force model included perturbations due to high order geopotential ( $50 \times 50$ ), with harmonic coefficients from JGM-2 model, and due to direct solar radiation pressure. The measurements model considered ionospheric correction [3].

The obtained data were evaluated through one parameter: error in position, given by:

$$\Delta \vec{r} \equiv \begin{bmatrix} x - \hat{x} \\ y - \hat{y} \\ z - \hat{z} \end{bmatrix} \quad (10)$$

which are after translated to radial, normal, and tranverse components of orbit fixed system [14, 15]. In Eq. (10),  $x_i$  and  $\hat{x}_i$  are the position reference and the position estimated components, respectively, in the orbit fixed reference frame.

Fig. 7 and Fig. 8 show the behavior of the error in position, given in meters, along time, given in seconds, considering only geopotential, and geopotential and direct solar radiation pressure effects, shown in two different curves. The graphics were plotted using data from 18/11/1993.

In the legends of Figures 5 to 8, “R” means radial component; “N” normal component; and “T” transverse component of orbit fixed system. The subscript “geo” means perturbations due to geopotential only; and “prs”, perturbations due to geopotential and direct solar radiation pressure.

Next, Table 5 shows the maximum and minimum values of the obtained errors for each of the perturbations considered.

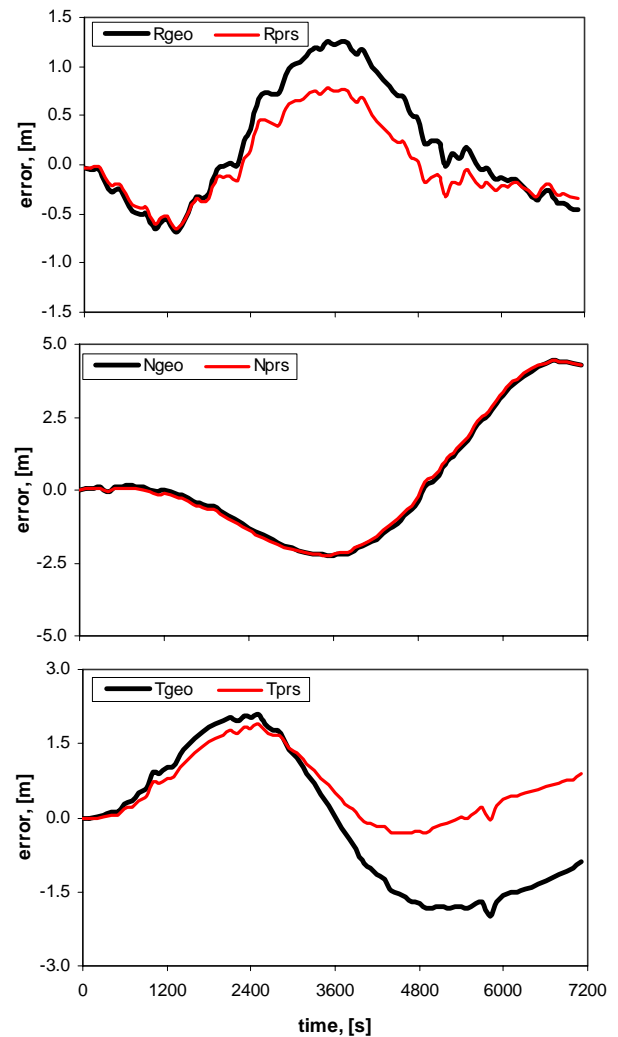

Fig. 7 - Errors in position, given in RNT coordinates, for 2 hours, comparing perturbations due to geopotential and direct solar radiation pressure.



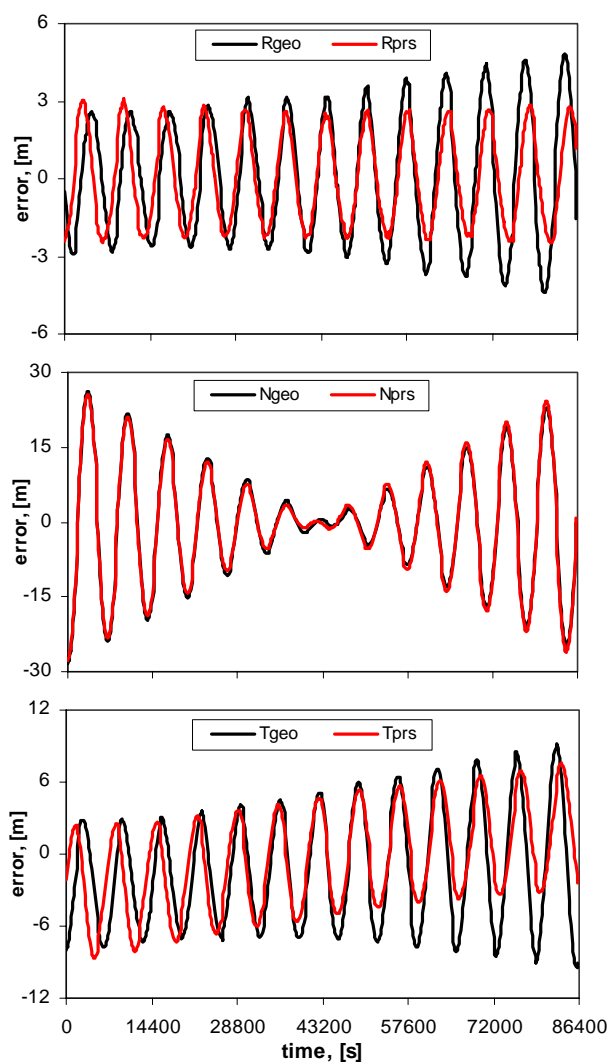

Fig. 8 - Errors in position, given in RNT coordinates, for 24 hours, comparing perturbations due to geopotential and direct solar radiation pressure.

Table 5 - Maximum and minimum values for errors.

Error (m)		2 hours			24 hours		
	value	R	N	T	R	N	T
geo	Max	1.48	4.44	2.19	5.70	26.26	9.27
	Min	-0.75	-2.28	-2.09	-4.67	-28.63	-12.43
prs	Max	0.84	4.49	1.89	4.90	25.60	7.70
	Min	-0.71	-2.21	-0.16	-2.69	-27.92	-8.70

As Table 5 shows, for short period (2 hours), solar radiation pressure decreases up to 43% the radial component value and up to 16% the transverse. And for the long one (24 hours), it reduces up to 42% the radial component value and up to 30% the transverse. The solar radiation

pressure does not act meanwhile on the normal component.

### 8 Conclusions

Using signals of the GPS constellation and least squares algorithms using sequential Givens rotations as the method of estimation, the principal aim here was to determine the orbit of an artificial satellite. The analysis period covered a short period (near once Topex’s period) and a long period (24 hours) of orbit determination.

Geopotential and direct solar radiation pressure were taken into consideration and the analysis occurred without selective availability on the signals measurements. Pseudo-range measurements were corrected from ionospheric effects, although the accuracy on orbit determination is not expressive [3]. Real time requirements were not present; meantime, it was appropriate to keep low computational cost, with accuracy enough to satellite positioning at 10 meters level for one day.

The results were compared with real data from Topex’s POE/JPL (Precision Orbit Ephemeris/Jet Propulsion Laboratory), available at Internet. For short period orbit determination, the magnitude of error in position varied from 4.6 m to 4.2 m, and for long period, the magnitude varied from 29.3 m to 27.8 m, according to the model’s complexness increase. As the numbers show, the model that includes direct solar radiation pressure decreases at most around 5% the precision in position. It happens because of the appearance of residual unmodeled accelerations due both perturbations.

In the analysis, remaining errors were found. They have periodic nature, with a frequency near the orbital period, due to the unmodeled residual accelerations, mentioned before, which appear by different reasons. In case of geopotential it may be caused by truncation of the harmonics of the geopotential field; whereas in the solar radiation pressure the possible causes are mismodeled attitude, self-shadowing, and differences between physical and simplified derived models. Assuming that we cope with the unmodeled accelerations, which have no direct physical reasons, or that the modeling effort is not worthwhile.

Throughout the results, it was found that least squares method through sequential Givens rotations and positioning using GPS showed trustfulness and accuracy enough for artificial satellites orbit determination.

Unfortunately, until now, it was not possible to solve the problem of these anomalous accelerations that affect the results. Although one knows the way

such accelerations might be modeled, in the programming phase, the modeling does not work out. It means that it will be necessary more information and knowledge about the problem to propose a reliable solution.

## 9 Acknowledgements

This work had financial supported by FAPESP (The State of São Paulo Research Foundation) under Grant 07/53256-1. The authors also wish to thanks INPE (Brazilian Space Research Institute).

### References:

- [1] <http://www.colorado.edu/geography/gcraft/notes/gps/gps.html>
- [2] Baroni, L.; Kuga, H. K. Iterated Least-Squares performance Evaluation with Real Data for Real Time Ambiguity Resolution. *Proceedings of the 8th WSEAS International Conference on SIGNAL, PROCESSING, and AUTOMATION*, Cambridge, UK, 2009, pp. 198-203.
- [3] Chiaradia, A. P. M.; Kuga, H. K.; Prado, A. F. B. A. Investigation on Ionospheric Correction Models for GPS Signals. Colóquio Brasileiro de Dinâmica Orbital, *Advances in Space Dynamics*, Vol.3, A. F. Bertachini A. Prado, Editor, 2000, pp. 214-219.
- [4] Kuga, H. K. *Noções Práticas de Técnicas de Estimacão*, Class Notes of Optimization on Dynamical Systems II, INPE, São José dos Campos, 2005.
- [5] Bierman, G. J.; Thornton, C. L. *Numerical comparison of Kalman filter algorithms: orbit determination case study*. Langley: NASA - Jet Propulsion Laboratory, 1976. 33 p. (IAF PAPER 76-015).
- [6] Givens, J. W. Computation of Plane Unitary Rotations Transforming a General Matrix to Triangular Form, *SIAM J. Appl. Math.*, Vol.6, 1958, pp. 26-50.
- [7] Silva, A. A. *Determinação de Órbitas com o GPS através de Mínimos Quadrados Recursivo co Rotações de Givens*. Dissertation (Master's Degree on Physics), FEG-UNESP, 2001.
- [8] Montenbruck, O.; Suarez, M. A *Modular Fortran Library for Sequential Least-Squares Estimation Using QR-Factorization*. DLR, German Space Operations Center, (DLR-GSOC IB 94-05), 1984.
- [9] Kaula, W. M. *Theory of Satellite Geodesy*. Blaisdell Publ. Co. Waltham, Mass, 1966.
- [10] Marshall, J. A.; Luthcke, S.B. 1994, Modeling radiation forces acting on Topex/Poseidon for precision orbit determination. *Journal of Spacecraft and Rockets*, Vol.31, N.1, 1994, pp. 99-106.
- [11] Binning, P. W. GPS, Dual Frequency, SA Free Satellite Navigation. Navigation Technology for the 3rd Millennium. *Proceedings of the 52nd Annual Meeting of the Institute of Navigation*, Cambridge, MA, 1996, pp. 803-812.
- [12] Marshall, J. A.; Antresian, P. G.; Rosborough, G. W.; Putney, B. H. Modeling Radiation Forces Acting on Satellites for Precision Orbit Determination. *Advances in the Astronautical Sciences*, AAS 91-357, Vol.76, Part I, 1991, pp. 72-96.
- [13] Soyka, M. T.; Davis, M. A. Estimation of Periodic Accelerations to Improve Orbit Ephemeris Accuracy. *Proceedings of the AAS/AIAA Space Flight Mechanics Meeting*, Vol.108, Part II, 2001, pp. 1123-1140.
- [14] Pardal, P. C. P. M. *Determinação de Órbita via GPS Considerando Modelo de Pressão de Radiação Solar para o Satélite Topex/Poseidon*. Dissertation (Master's Degree on Aerospace Engineering and Tecnology), INPE, 2007.
- [15] Pardal, P. C. P. M.; Kuga, H. K.; Vilhena de Moraes, R. Recursive Least Squares Algorithms Applied to Satellite Orbit Determination, Using GPS Signals. *Proceedings of the 8th WSEAS International Conference on SIGNAL, PROCESSING, and AUTOMATION*, Cambridge, UK, 2009, pp. 167-172.
- [16] Gomes, V. M.; Prado, A. F. B. A.; Kuga, H.K. Orbital Maneuvers Using Low-Thrust. *Proceedings of the 8th WSEAS International Conference on SIGNAL, PROCESSING, and AUTOMATION*, Cambridge, UK, 2009, pp. 120-125.