

SAEMC_GRID: South America Megacities Emissions and Climate Grid

LAGrid 2008

Luiz Henrique Coura (INPE/CPTEC) - luiz.coura@cptec.inpe.br

Agenda

- Introduction
- SAEMC Project
- Tools
 - CATT-BRAMS and CCATT-BRAMS
 - GBRAMS Project
- Objective
- SAEMC Grid Portal
- Network support
- SAEMC Computational Grid
- Future plans

Introduction

Megacities concentrate anthropogenic sources of atmospheric pollutants with consequences on local air quality and on regional and global atmospheric chemistry.

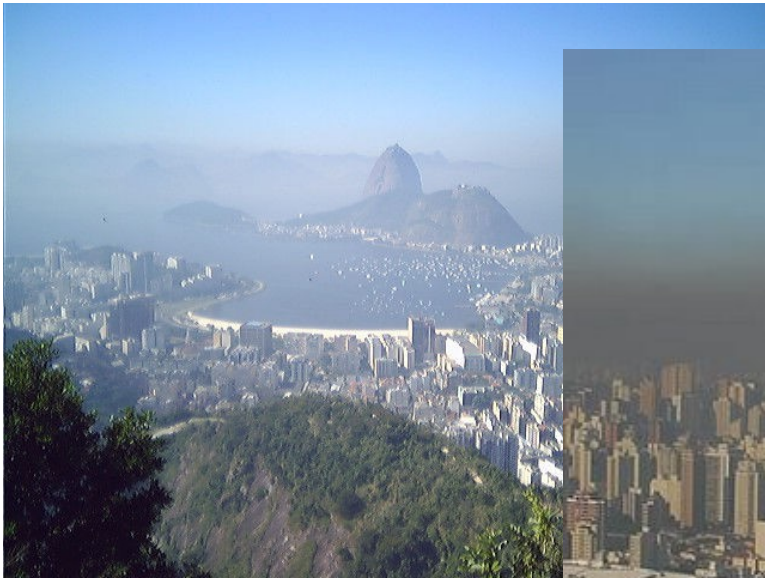

Rio de Janeiro - Brazil

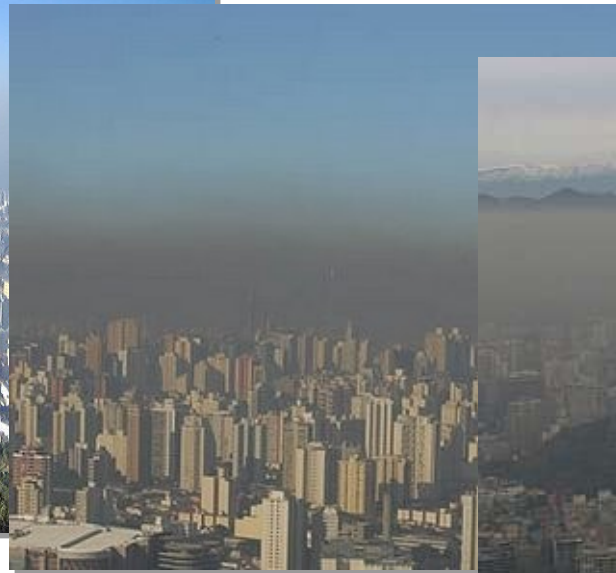

São Paulo - Brazil



Santiago - Chile

SAEMC project

South American Emissions, Megacities and Climate project is a joint effort between several South American institutions funded by the Inter-American Institute for Global Change Research (IAI).

Goals

- To provide accurate regional emissions and climate change scenarios for South America, with emphasis on the impacts of and on megacities.
- To establish the basis for operational chemical weather forecast for South American megacities.
- To strengthen and expand an active research and capacity building network in the Americas functional to Earth System Modeling.

SAEMC project

Expected Results

- The proposed work will provide regional scale past, present and future climate change scenarios, with a unique emphasis on the evolution of air quality in South American megacities, where more than 75% of the population of the continent lives. Such high resolution scenarios are not currently available for this area of the world.
- Comparable estimate and evaluation methodologies, as well as, reconciled local, regional and global scale emission inventories will be produced for South America, a region up to date poorly constrained in this respect despite its potential vulnerability to global change and its effects, particularly in megacities.

SAEMC project

Expected Results

- A well established and enhanced research network, particularly in terms of educated human resources, able to better contribute to and lead global change research in the Americas within the framework of Earth System Modeling.
- Unique and new databases functional to various other relevant research issues and assessments, among which human health, ecology, water and energy resources, economics and city planning.

SAEMC project

Methodology and approach

- Mobile and Stationary emissions scenarios estimate and evaluation
- Dynamical down-scaling of climate change scenarios
- **Pilot implementation of chemical weather forecast network and tools for South American megacities (SAEMC_GRID)**
- Prospective characterization of aerosols in and downwind from South American megacities

Tools

Numerical Models (environmental model)

Grid Computing

Where will it stop?



CATT-BRAMS

Coupled **A**erosol and **T**racer **T**ransport model to the **B**razilian developments on the **R**egional **A**tmospheric **M**odeling **S**ystem is an on-line transport model fully consistent with the simulated atmospheric dynamics. The atmospheric transport of emissions is studied through a numerical simulation of the air mass motions using it.

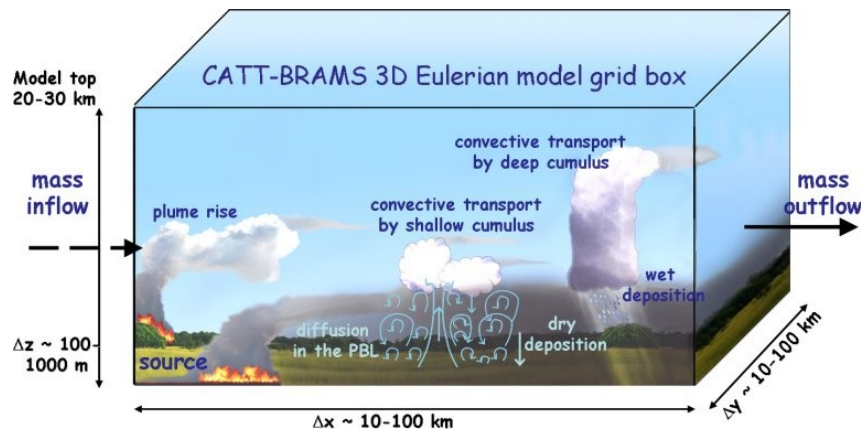

Some sub-grid process involved at gases/aerosols transport and simulated by CATT-BRAMS model

CATT-BRAMS

It's currently the operational air quality model at INPE/CPTEC

<http://meioambiente.cptec.inpe.br>

CCATT-BRAMS

Coupled **C**hemistry **A**erosol and **T**racer **T**ransport model to the **B**razilian developments on the **R**egional **A**tmospheric **M**odeling **S**ystem.

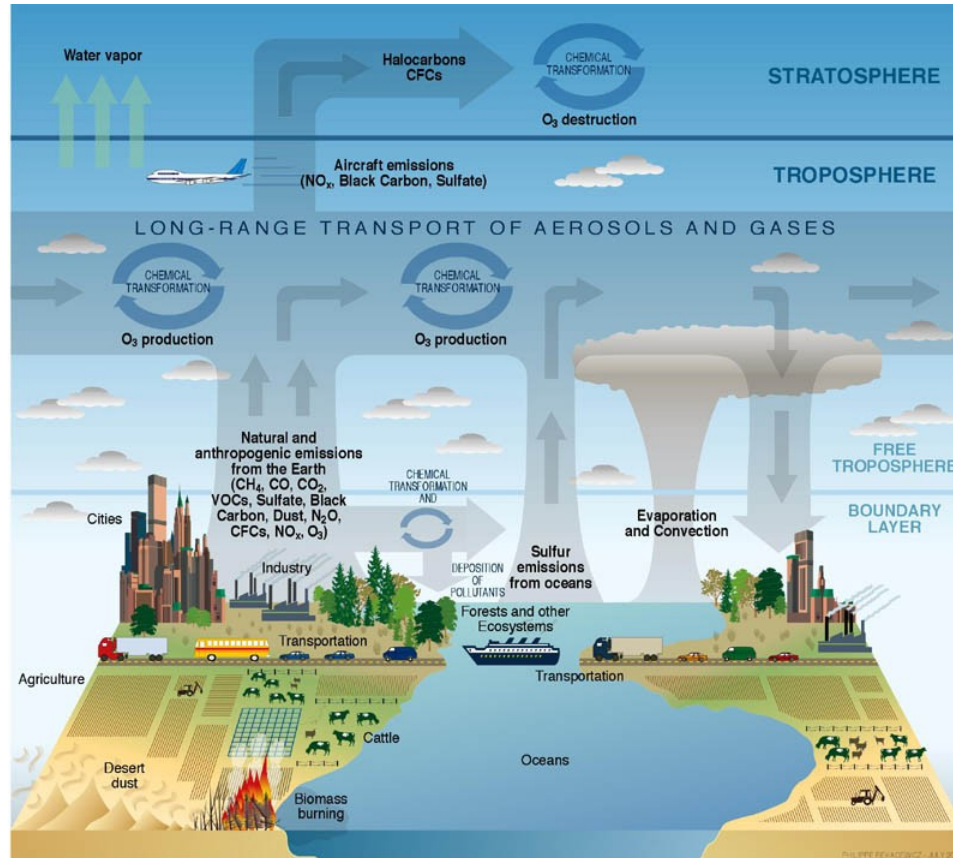

GBRAMS Project

Goals

- Test viability of grids for meteorological numerical models
- Generate ten years monthly of meteorological model BRAMS climatology, based in ensemble means (three members)
- Strategy applied for three regions of Brazil: North, Northeast and South/Southeast
- Three grid middleware compared (GLOBUS, OAR/CIGRI and OURGRID)

GBRAMS Project

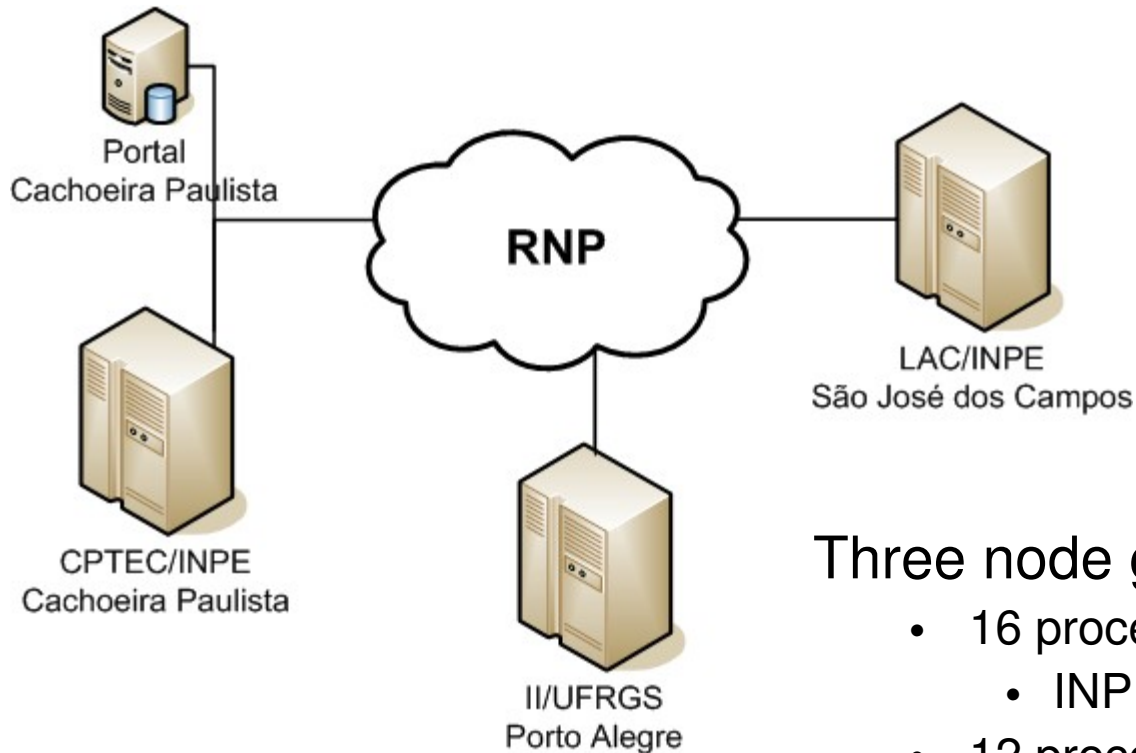

Three node grids:

- 16 processors Xeon 3.0 GHz:
 - INPE/CPTEC (Cachoeira Paulista)
- 12 processors Opteron 2.6 GHz;
 - INPE/LAC (São José dos Campos)
 - II/UFRGS (Porto Alegre)

GBRAMS Project

Regional climatology was obtained using an average over the ensemble, which is a set of BRAMS long range integration for each one of the **3 areas**: North, Northeast e South/Southeast.

The **3 areas** and **3 members** simulation represents **9 independent integrations**. Therefore, these integrations can be executed in the same time, if there are computing resources available.

In order to the execution becomes more flexible, each N years integration, one area and one member was divided by year, splitted in small executions (jobs) that, although they depend on each other, they can be executed in different computers as become available.

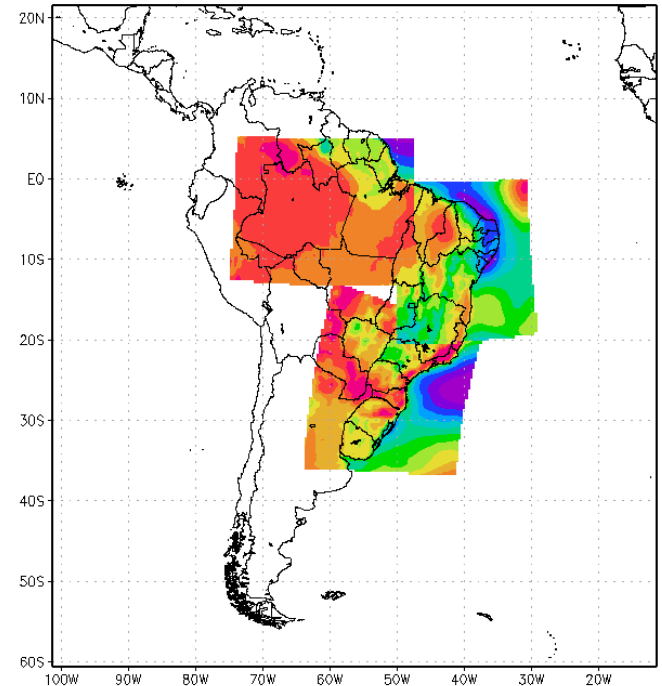

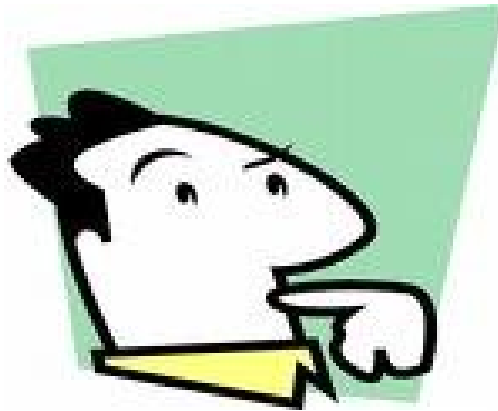

Data processing for each megacity can be considered independent.

Well suitable for running in geographically distributed clusters, using Grid technology.

Objective

The main idea of this proposal is to describe a project for a computational grid that will be accessed through a grid portal where the CCATT-BRAMS will be used as chemical weather forecast for selected megacities of South America.

SAEMC Grid Portal

- Job Submission
- Job Management
- Data Presentation

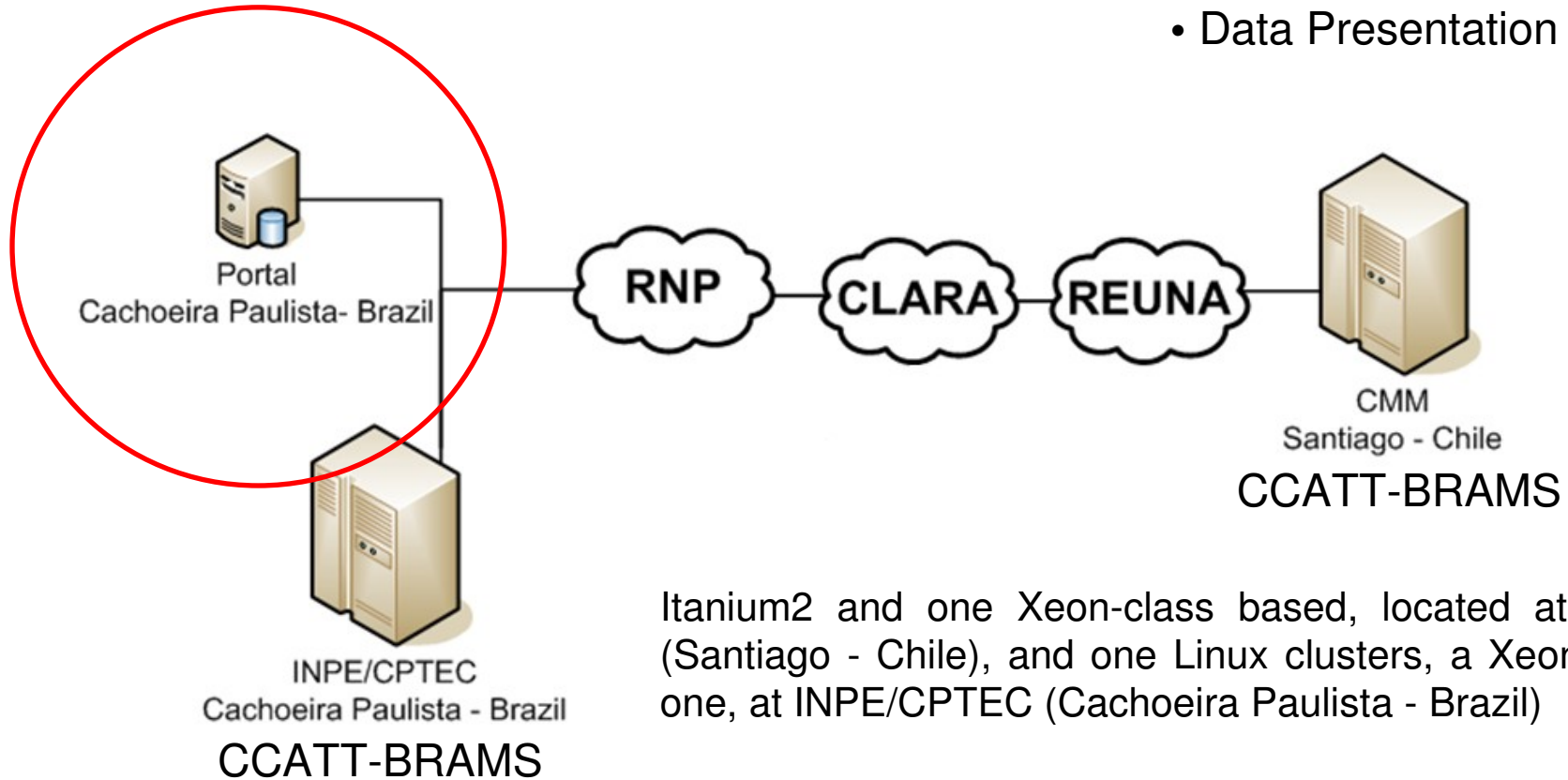

Itanium2 and one Xeon-class based, located at CMM (Santiago - Chile), and one Linux clusters, a Xeon-class one, at INPE/CPTEC (Cachoeira Paulista - Brazil)

SAEMC Grid Portal: Job Submission

The screenshot shows a web browser window titled "GridSphere Portal - Mozilla Firefox". The address bar contains the URL "http://pcmake:8080/gridsphere/grdsphere/loggedin/Submission/r/". The page header includes the text "SAEMC GRID PORTAL" in red, followed by "South American Emissions, Megacities and Climate" in blue. A navigation menu contains links for "Home", "Submission" (which is highlighted), "Management", and "Presentation". Below the menu is a yellow "Submit" section with a "RAMSIN:" label and a file upload area containing "Arquivo..." and "Carregar arquivo" buttons. There are also "Salvar" and "Cancelar" buttons. A row of tabs includes "MODEL_GRIDS", "MODEL_FILE_INFO", "MODEL_OPTIONS", "MODEL_SOUND", "MODEL_PRINT", "ISAN_CONTROL", and "ISAN_ISENTRCPIC". The "MODEL_OPTIONS" tab is selected. Below the tabs are several input fields for parameters: EXPNME, RUNTYPE, TIMEUNIT, TIMMAX, LOAD_BAL, IMONTH1, IDATE1, IYEAR1, IIME1, NGRIDS, NNX, and NNYP. The status bar at the bottom of the browser window displays "Concluido".

GridSphere Portal - Mozilla Firefox

Arquivo Editar Exibir Histórico Favoritos Ferramentas Ajuda

http://pcmake:8080/gridsphere/grdsphere/loggedin/Submission/r/

SAEMC GRID PORTAL

Welcome , Admin Admin [Administration](#) [Content](#) [Layout](#) [Profile](#) [Home](#) [Logout](#)

South American Emissions, Megacities and Climate

Home **Submission** Management Presentation

Submit

RAMSIN:

MODEL_GRIDS MODEL_FILE_INFO MODEL_OPTIONS MODEL_SOUND MODEL_PRINT ISAN_CONTROL ISAN_ISENTRCPIC

EXPNME:

RUNTYPE:

TIMEUNIT:

TIMMAX:

LOAD_BAL:

IMONTH1:

IDATE1:

IYEAR1:

IIME1:

NGRIDS:

NNXP:

NNYP:

Concluido

SAEMC Grid Portal: Job Management

The screenshot shows the SAEMC Grid Portal interface in Mozilla Firefox. The browser title is "GridSphere Portal - Mozilla Firefox". The address bar shows the URL: <http://pcmake:8080/gridsphere/gridsphere/loggedin/Management/r/>. The page header includes the text "SAEMC GRID PORTAL" in red, followed by "South American Emissions, Megacities and Climate" in blue. A navigation menu contains buttons for "Home", "Submission", "Management" (which is active), and "Presentation". Below the menu is an "Upload" section with buttons for "Criar Job", "Executar", and "Resultados". The main content area is titled "Lista de Jobs SAEMC" and contains a table with columns: ID, Criacao, Inicio da Execucaao, Fim da Execucaao, Estado, and Host. The table lists 13 jobs, all with the state "ACEITA" and host "pcmake.cptec.inpe.br".

Welcome , Admin Admin [Administration](#) [Content](#) [Layout](#) [Profile](#) [Home](#) [Logout](#)

SAEMC GRID PORTAL
South American Emissions, Megacities and Climate

Home Submission **Management** Presentation

Upload

Criar Job Executar Resultados

Lista de Jobs SAEMC

-	ID	Criacao	Inicio da Execucaao	Fim da Execucaao	Estado	Host
<input type="checkbox"/>	100	21.11.08 - 12:42	21.11.08 - 20:35	21.11.08 - 23:35	ACEITA	pcmake.cptec.inpe.br
<input type="checkbox"/>	101	21.11.08 - 12:42	21.11.08 - 20:35	21.11.08 - 23:35	ACEITA	pcmake.cptec.inpe.br
<input type="checkbox"/>	102	21.11.08 - 12:42	21.11.08 - 20:35	21.11.08 - 23:35	ACEITA	pcmake.cptec.inpe.br
<input type="checkbox"/>	103	21.11.08 - 12:42	21.11.08 - 20:35	21.11.08 - 23:35	ACEITA	pcmake.cptec.inpe.br
<input type="checkbox"/>	104	21.11.08 - 12:42	21.11.08 - 20:35	21.11.08 - 23:35	ACEITA	pcmake.cptec.inpe.br
<input type="checkbox"/>	105	21.11.08 - 12:42	21.11.08 - 20:35	21.11.08 - 23:35	ACEITA	pcmake.cptec.inpe.br
<input type="checkbox"/>	106	21.11.08 - 12:42	21.11.08 - 20:35	21.11.08 - 23:35	ACEITA	pcmake.cptec.inpe.br
<input type="checkbox"/>	107	21.11.08 - 12:42	21.11.08 - 20:35	21.11.08 - 23:35	ACEITA	pcmake.cptec.inpe.br
<input type="checkbox"/>	108	21.11.08 - 12:42	21.11.08 - 20:35	21.11.08 - 23:35	ACEITA	pcmake.cptec.inpe.br
<input type="checkbox"/>	109	21.11.08 - 12:42	21.11.08 - 20:35	21.11.08 - 23:35	ACEITA	pcmake.cptec.inpe.br
<input type="checkbox"/>	110	21.11.08 - 12:42	21.11.08 - 20:35	21.11.08 - 23:35	ACEITA	pcmake.cptec.inpe.br
<input type="checkbox"/>	111	21.11.08 - 12:42	21.11.08 - 20:35	21.11.08 - 23:35	ACEITA	pcmake.cptec.inpe.br
<input type="checkbox"/>	112	21.11.08 - 12:42	21.11.08 - 20:35	21.11.08 - 23:35	ACEITA	pcmake.cptec.inpe.br
<input type="checkbox"/>	113	21.11.08 - 12:42	21.11.08 - 20:35	21.11.08 - 23:35	ACEITA	pcmake.cptec.inpe.br

SAEMC Grid Portal: Data Presentation

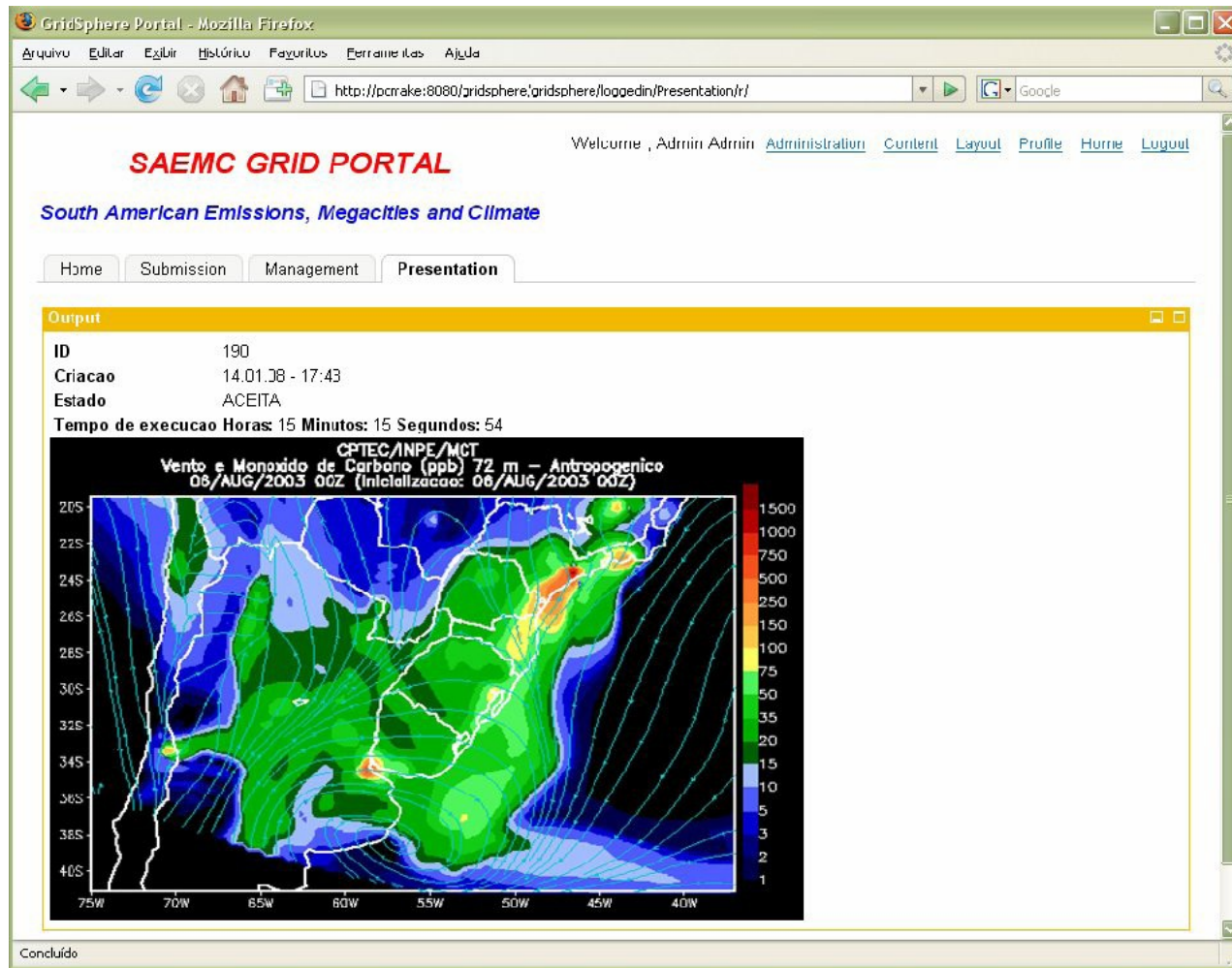

Network Support - RNP

RNP

National Network
for Education and
Research

INPE/CPTEC

155 Mbps high
availability
connection

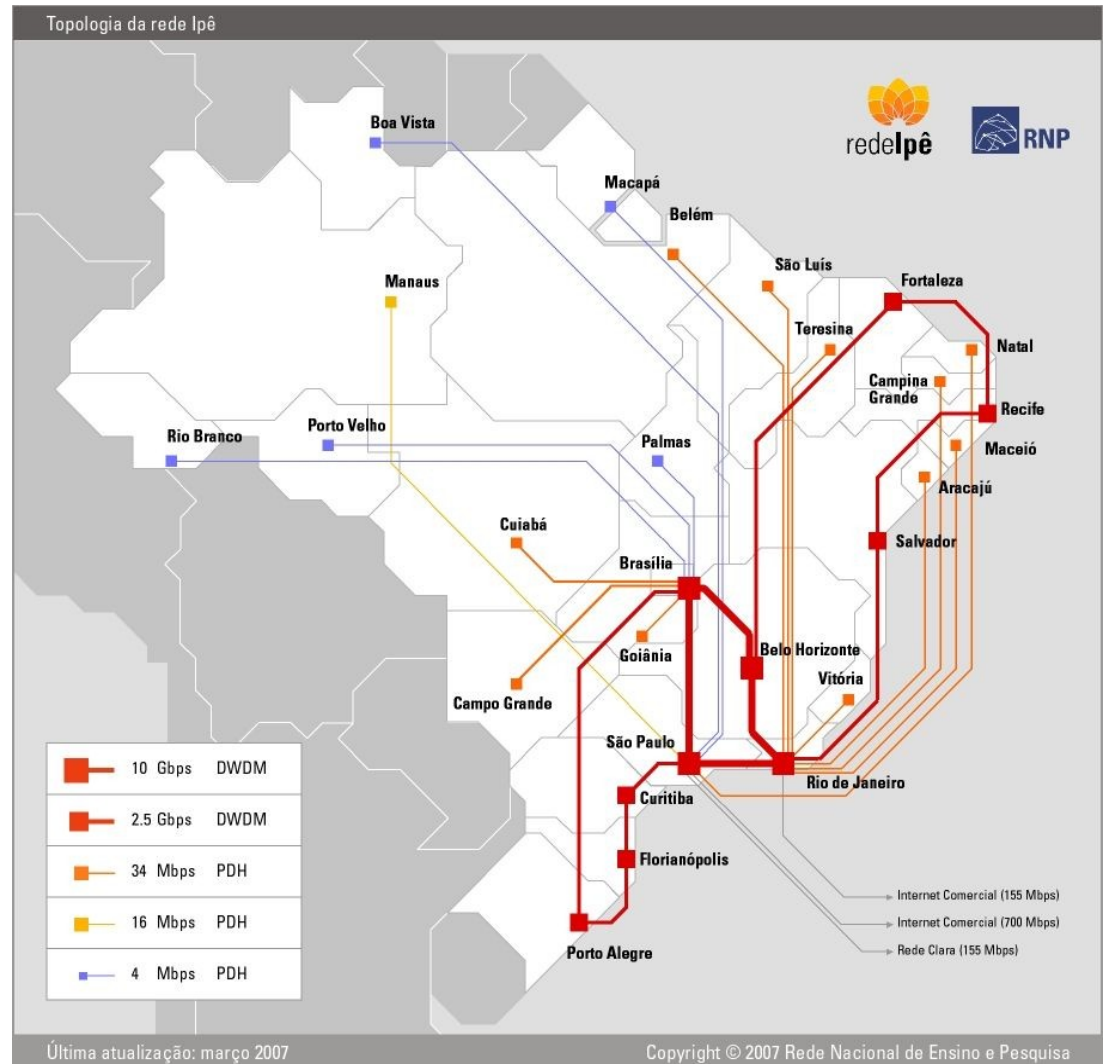

Network Support - CLARA

CLARA

Cooperación
Latino Americana
de Redes
Avanzadas

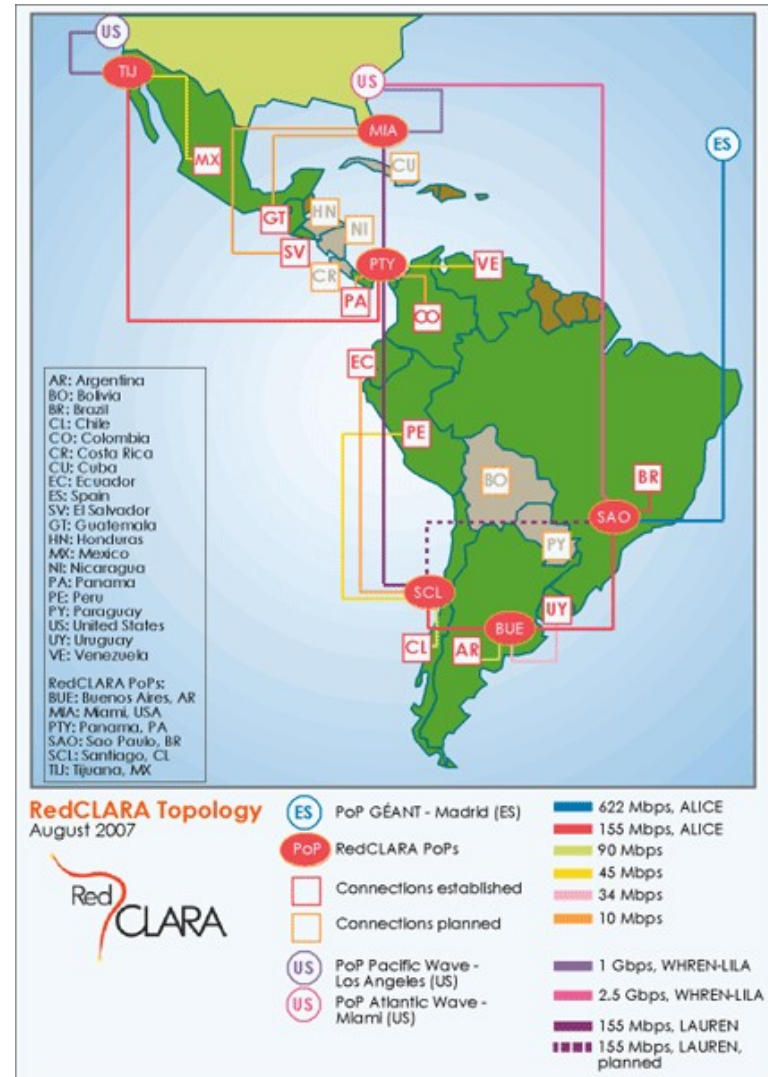

Network Support - REUNA

REUNA

Red
Universitaria
Nacional

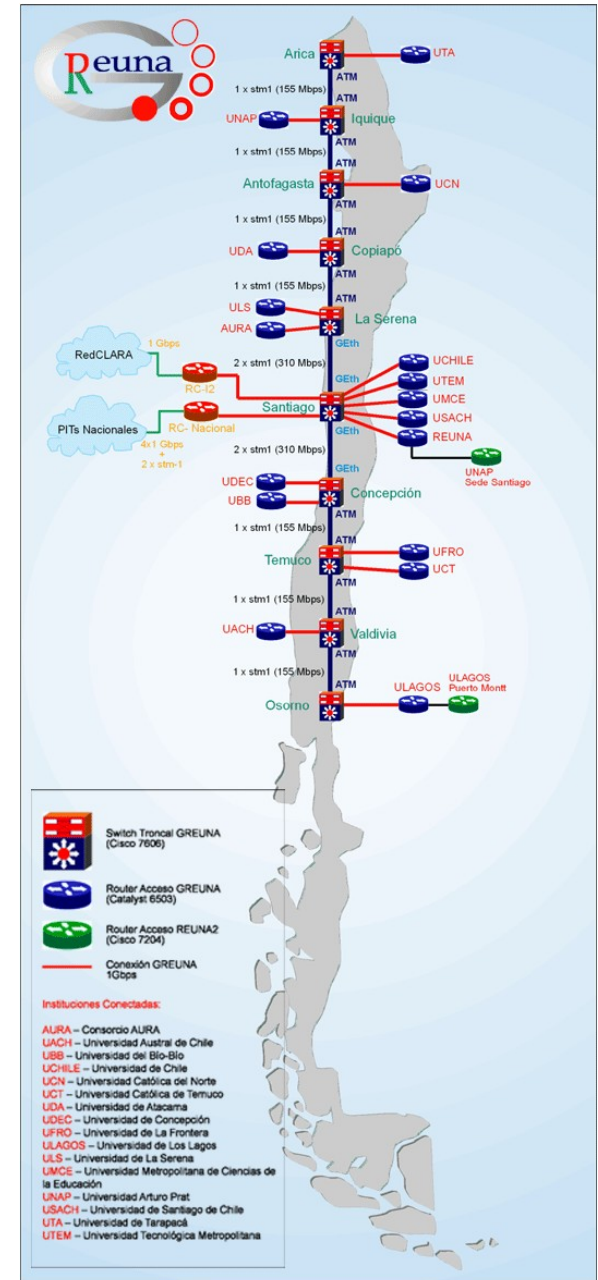

SAEMC Computational Grid

Globus Toolkit will be used as middleware to connect Linux clusters:

- User identification (GSI – Grid Security Infrastructure)
- Control and submission of jobs (GRAM – Globus Resource Allocation Manager)
- Safe mechanism for data transfer (GridFtp)
- Workflow management
- Metascheduler (GridWay)

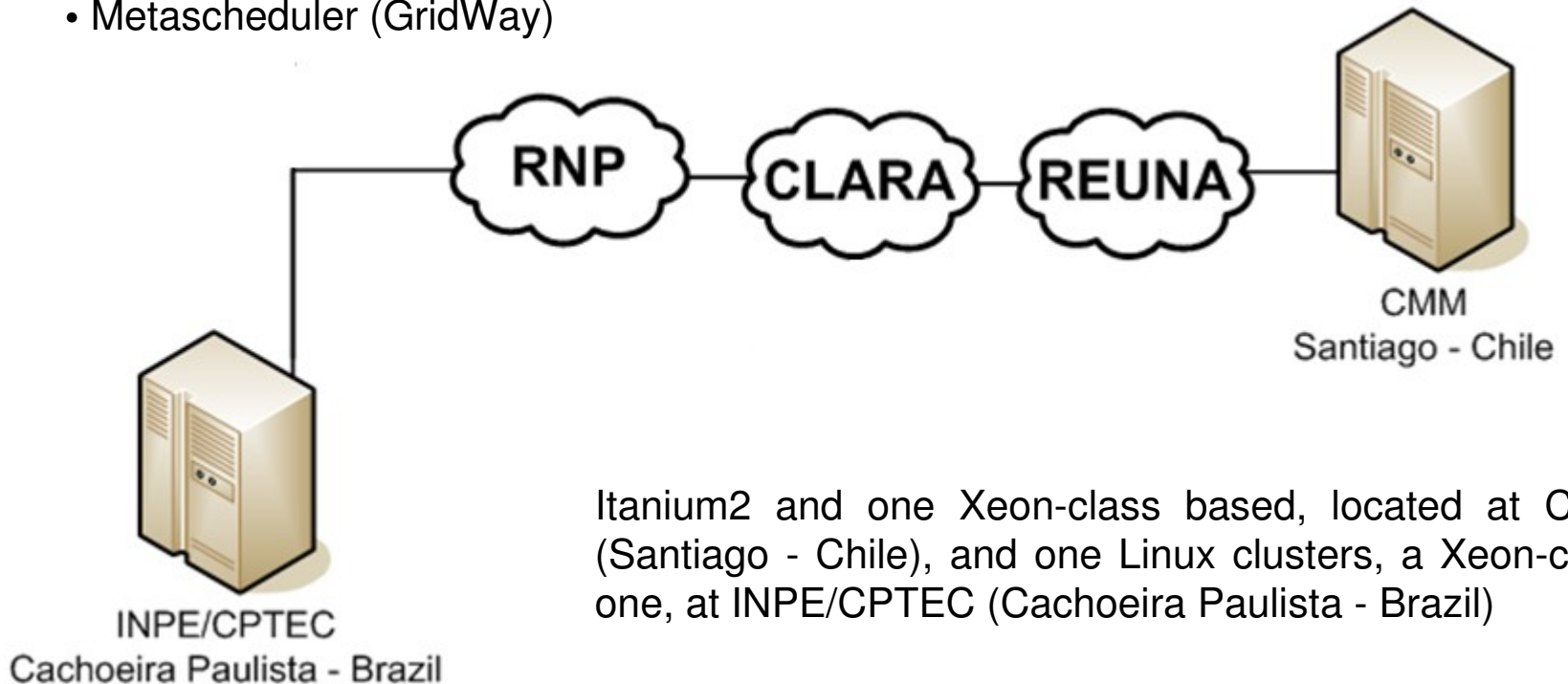

Itanium2 and one Xeon-class based, located at CMM (Santiago - Chile), and one Linux clusters, a Xeon-class one, at INPE/CPTEC (Cachoeira Paulista - Brazil)

Future plans

- Connect CNEA (Argentina) and UPB (Colombia) to computational grid

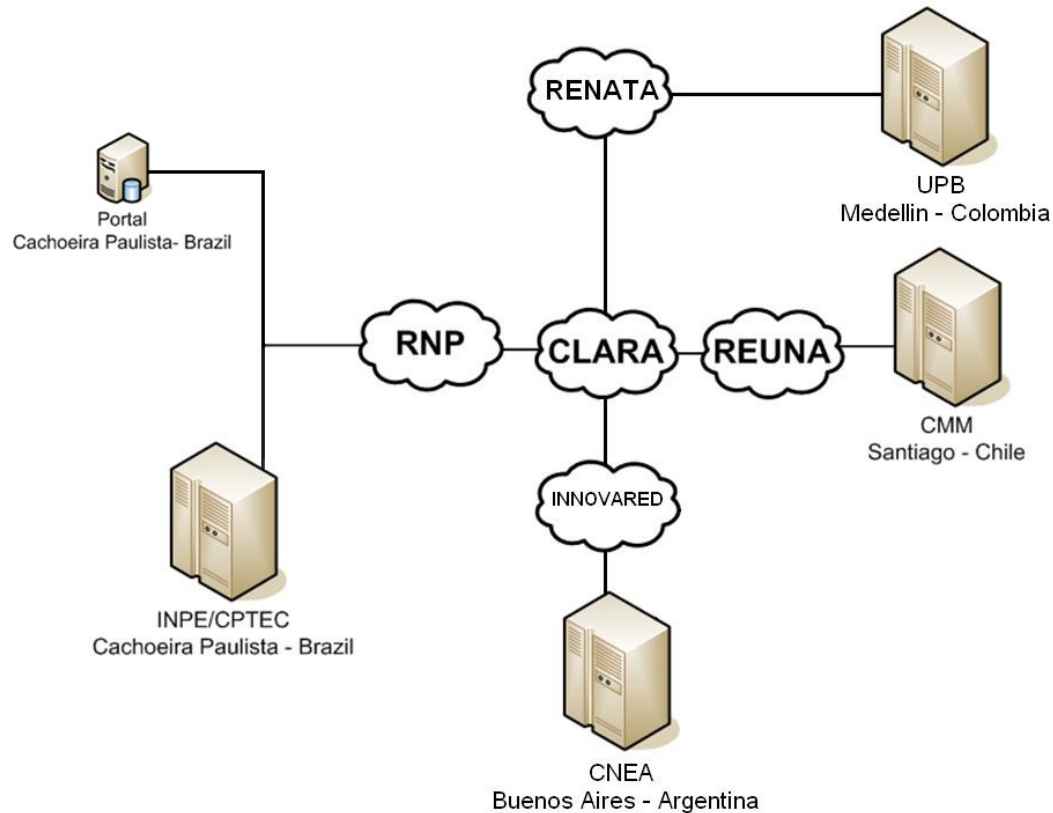

Thank you!

Questions?