

# LES Applied to Analyze the Turbulent Flow Organization above Amazon Forest

Cléo Q. Dias Júnior;  
Leonardo D. A. Sá;  
Edson P. Marques Filho  
Luís A. Cândido  
Antônio O. Manzi.





# NOCTURNAL TURBULENT REGIMES ACCORDING TO SUN et al. (2012):

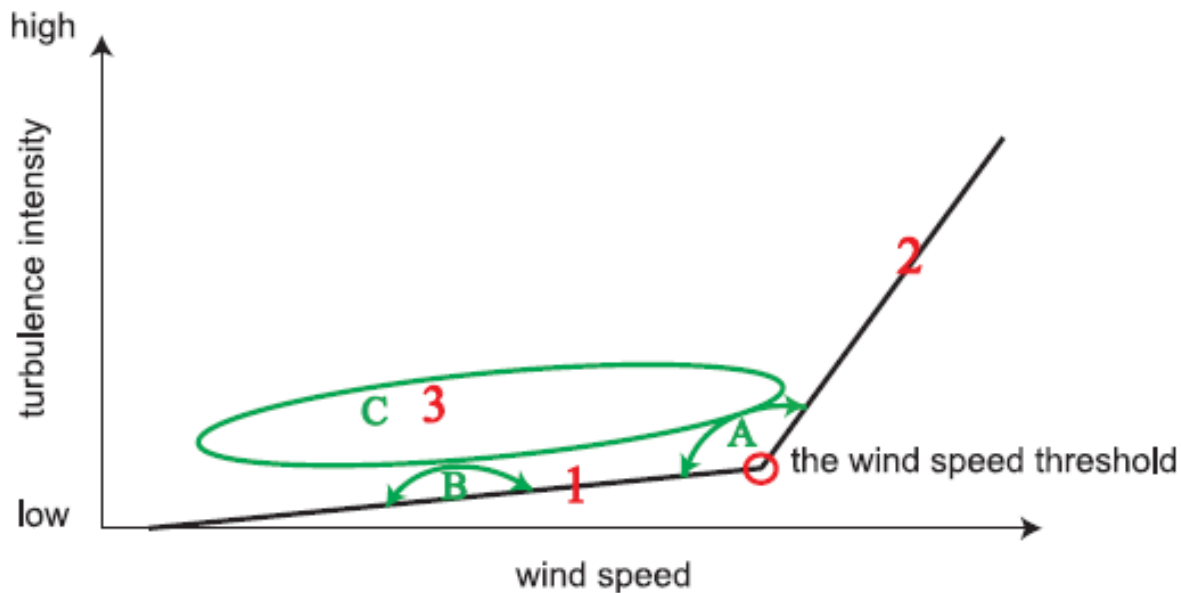

Fig.1: Sun et al. (2012)

FIG. 2. Schematic of the three turbulence regimes (red numbers) and the three categories of turbulence intermittency (green letters) commonly observed during CASES-99 at each observation height. Turbulence in regime 1 is mainly generated by local instability. Turbulence in regime 2 is mainly generated by the bulk shear. Turbulence in regime 3 is mainly generated by top-down turbulent events.

# NOCTURNAL TURBULENT REGIMES ACCORDING TO SUN et al. (2012):

The regimes 1 and 2 were classified according to relationship between the scale of turbulent velocity ( $V_{TKE}$ ) and the mean wind velocity,  $U$ .

$V_{TKE}$  is defined as:

$$V_{TKE} = \left[ (1/2) \left( \sigma_u^2 + \sigma_v^2 + \sigma_w^2 \right) \right]^{1/2}$$

# SOME RESULTS FOR REBIO JARÚ

a)

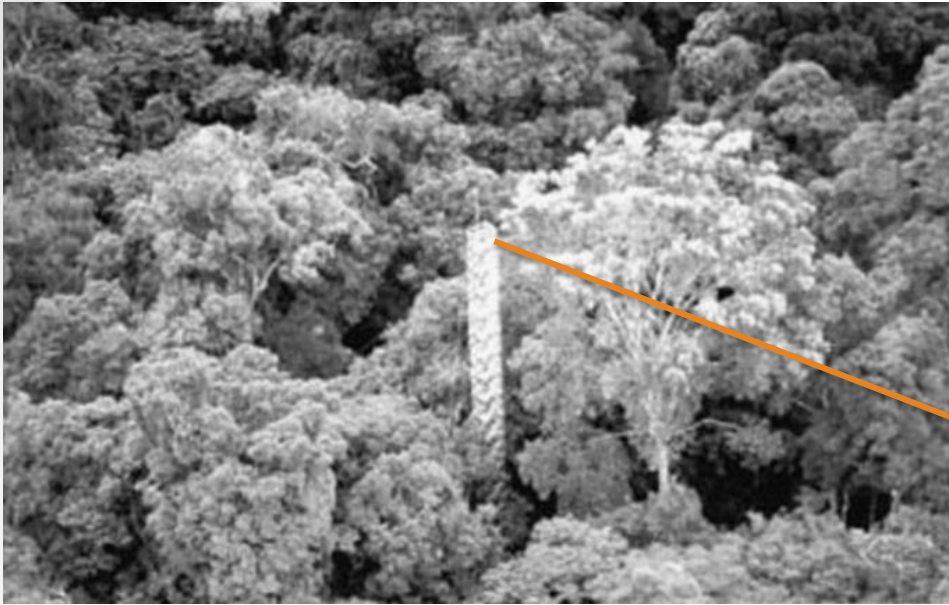

b)



**Fig. 2.** a) Meteorological tower erected at Rebio-Jaru forest reserve. b) Cup anemometers ranged at different heights in the meteorological tower at Rebio-Jaru.

Source: Dias-Junior et al. (2013)

The wind speed data was measured by 10 cup anemometers arranged in suitable heights to give accurate resolution information regarding the inflection point height,  $z_i$

# NOCTURNAL TURBULENT REGIMES ABOVE REBIO-JARÚ FOREST

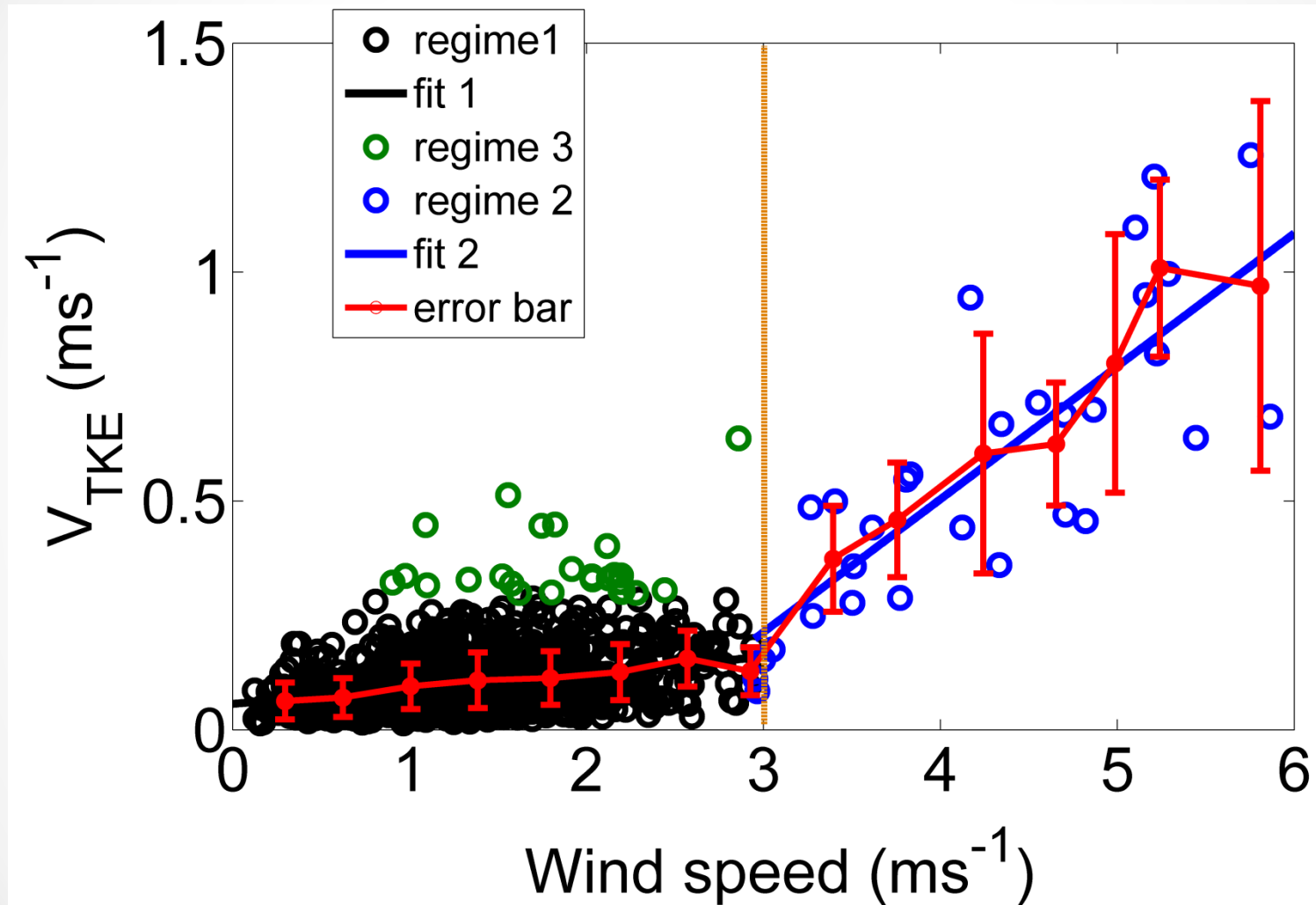
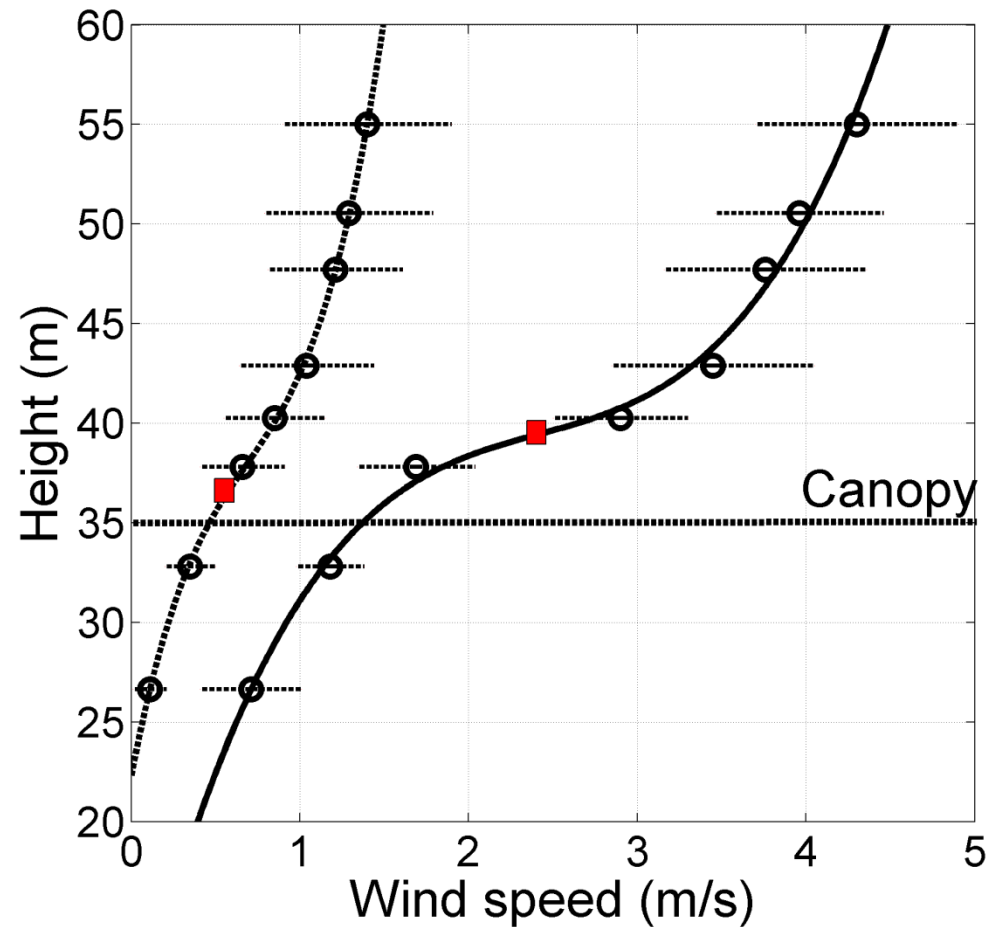

Fig. 3. Turbulence intensity  $V_{TKE}$  against wind speed.

# NOCTURNAL TURBULENT REGIMES ABOVE REBIO-JARÚ FOREST



**Fig. 4.** Inflection point height for regime 1 and regime 2.

# THE CANOPY-MIXING LAYER ANALOGY



Fig. 5: Raupach et al. (1996)

They made a direct comparison between features of the coherent structures in the roughness sublayer and the mixing layer



# THE CANOPY-MIXING LAYER ANALOGY

Dias-Junior et al. (2013) shown that there is a close relationship between time scale of the coherent structure and the height to the inflection point in the mean wind speed profile for daytime conditions above Rebio-Jarú forest.

Robinson (1991) suggests that coherent structures that have high temporal scales are organized in the form of rolls with axes of symmetry perpendicular to the direction of the mean flow and are less dissipative.

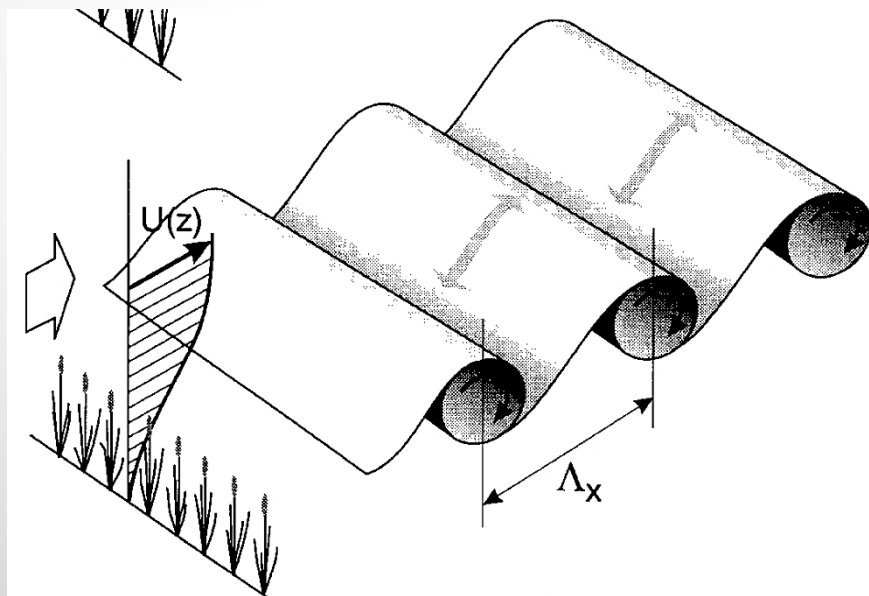

**Fig. 6:** Roll's coherent structure.  
Source: Finnigan (2000)

## NUMERICAL IMPLEMENTATION:

A numerical grid of  $128 \times 128 \times 256$  points distributed an area of  $2 \times 2 \text{ Km}^2$  in the horizontal and up to 1 Km in the vertical direction was used (15.62 m on the horizontal and 3.9 m on the vertical).

Was used  $\theta = 304 \text{ K}$  (potential temperature).

The drag force generated by the canopy ( $\bar{F}$ ) can be written as follows Patton et al. (2003):

$$\bar{F} = -c_d \text{LAI} |\bar{u}| \bar{u}$$

LAI equal to 5.0 (Marques Filho et al., 2005)

## NUMERICAL IMPLEMENTATION:

The average canopy height ( $h$ ) equal to 35 m (Andreae et al., 2002).

Was used LAD similar to that found by Marques Filho et al. (2005)

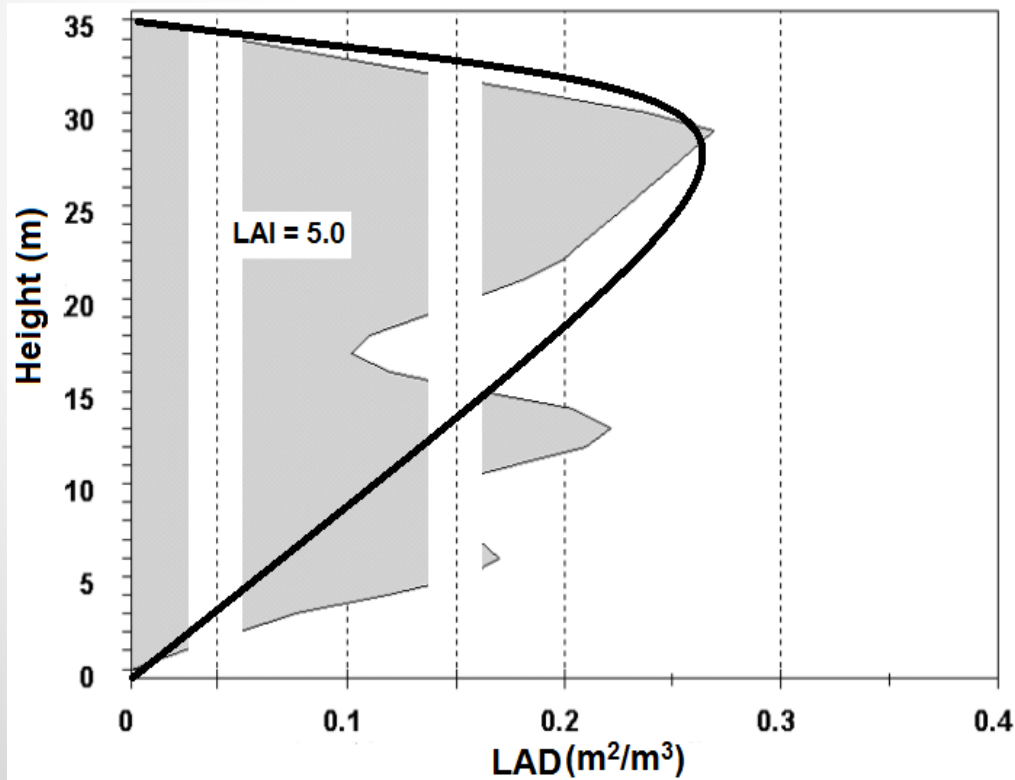

**Fig. 7** Vertical Profile of leaf area density of the Rebio Jarú forest reserve (gray region) and modifications inserted in the LES (black line).

Source: Dias-Junior et al. (2015) (submitted to JWEIA)

# SOME RESULTS FOR REBIO JARÚ

The simulation's results show clearly that the atmospheric flow is sensitive to the presence of the forest canopy

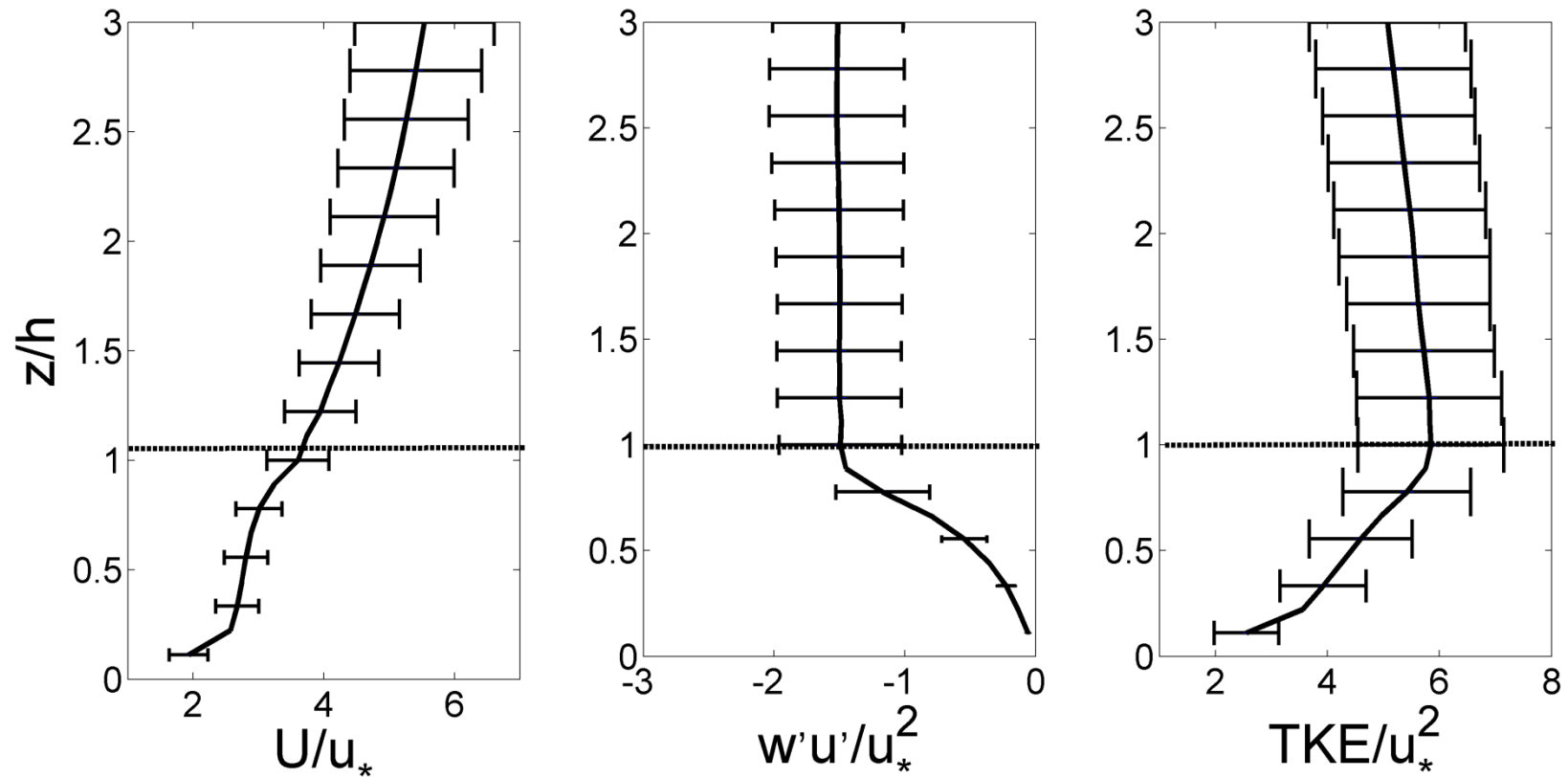

Fig. 8 Vertical Profiles . Source: Dias-Junior et al. (2015) (submitted to JWEIA)

# LES RESULTS

Well above canopy was have been successfully simulated some peculiar features of the like “rolls” CSs, such as:

# LES RESULTS

i) the skewness of the wind velocity has a maximum value on the region between  $1h$  and  $4h$ , what indicates an asymmetric distribution of the wind velocity relatively to its mean value, fact that might be associated to the generation process of the “roll” structures;

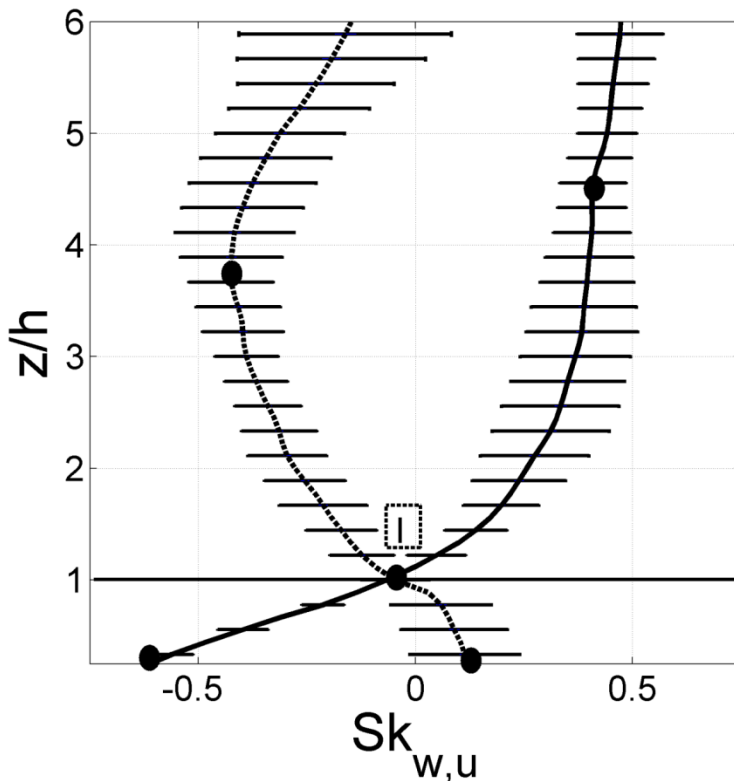
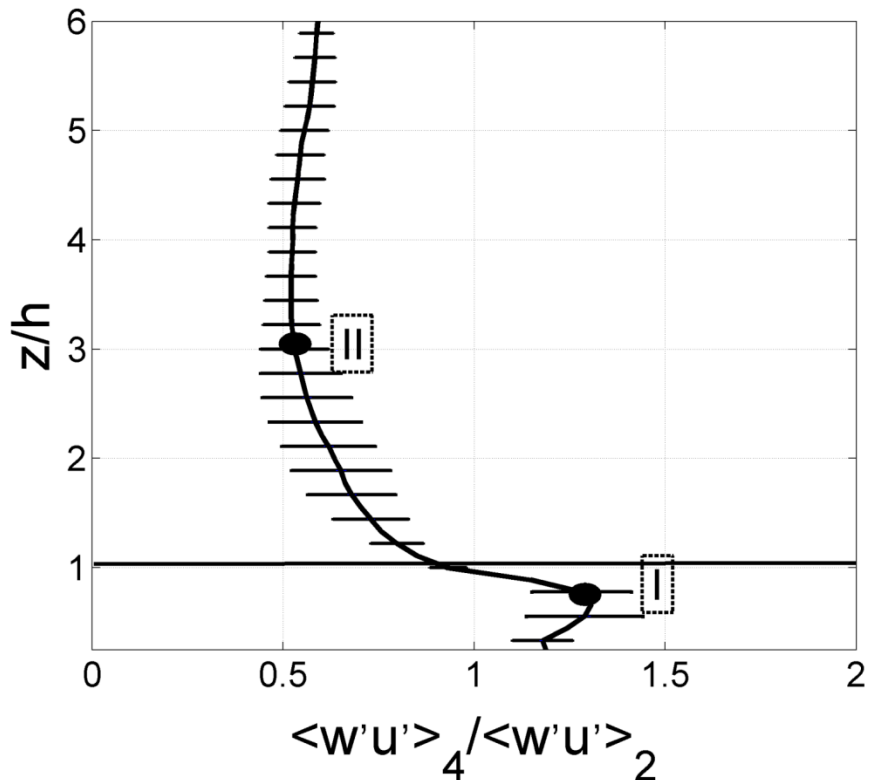

**Fig. 9** Vertical Profile of leaf area density of the Rebio Jarú forest reserve (gray region) and modifications inserted in the LES (black line).

Source: Dias-Junior et al. (2015) (submitted to JWEIA) )

# LES RESULTS

ii) the ratio  $R = \langle w'u' \rangle_4 / \langle w'u' \rangle_2$ . It can be observed that within the vegetation, the sweeps contribute more significantly for  $\langle w'u' \rangle$  than the ejections.

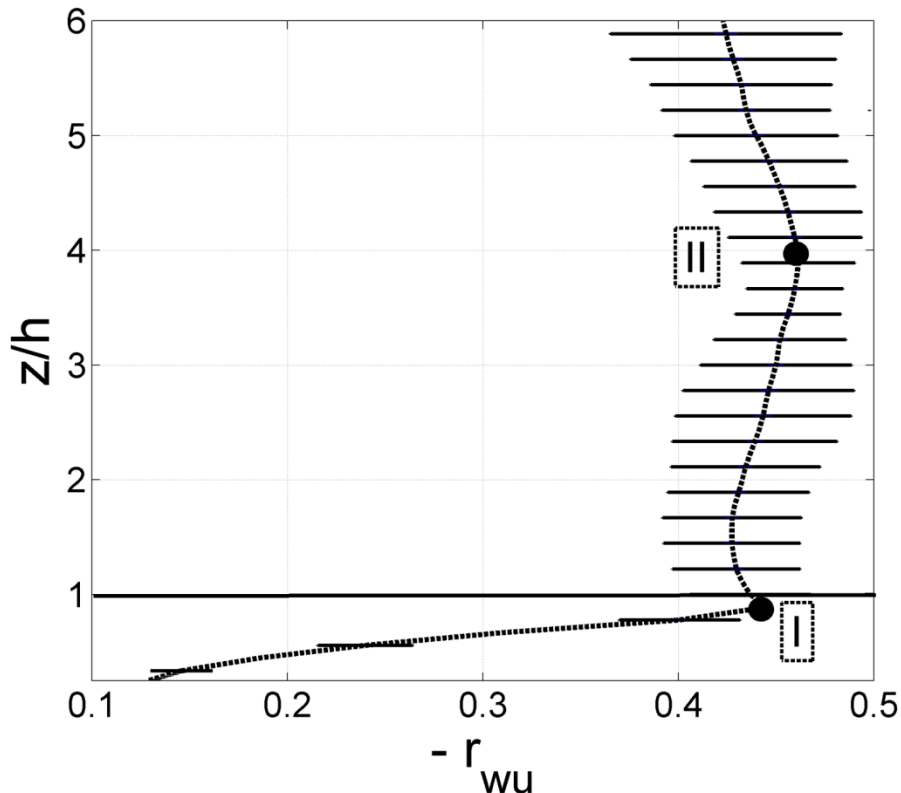

**Fig. 10** Flux ratio: momentum flux by sweep ( $w' < 0$  e  $u' > 0$ ) to that by ejection ( $w' > 0$  e  $u' < 0$ ).

Source: Dias-Junior et al. (2015)  
(submitted to JWEIA)

# LES RESULTS

iii) The values of  $r_{wu}$  (Fig. 7) and the turbulent intensities ( $\sigma_u$  and  $\sigma_w$ ) in the region close to the canopy top (Fig 5b) would be connected among them generating rolls in forest-atmosphere interface in a similar way, as obtained by different authors in their studies concerning the flow over different types of tall vegetation (Kanda and Hino, 1994; Dupont et al.; 2008; Dupont and Brunet, 2009; Finnigan et al., 2009).

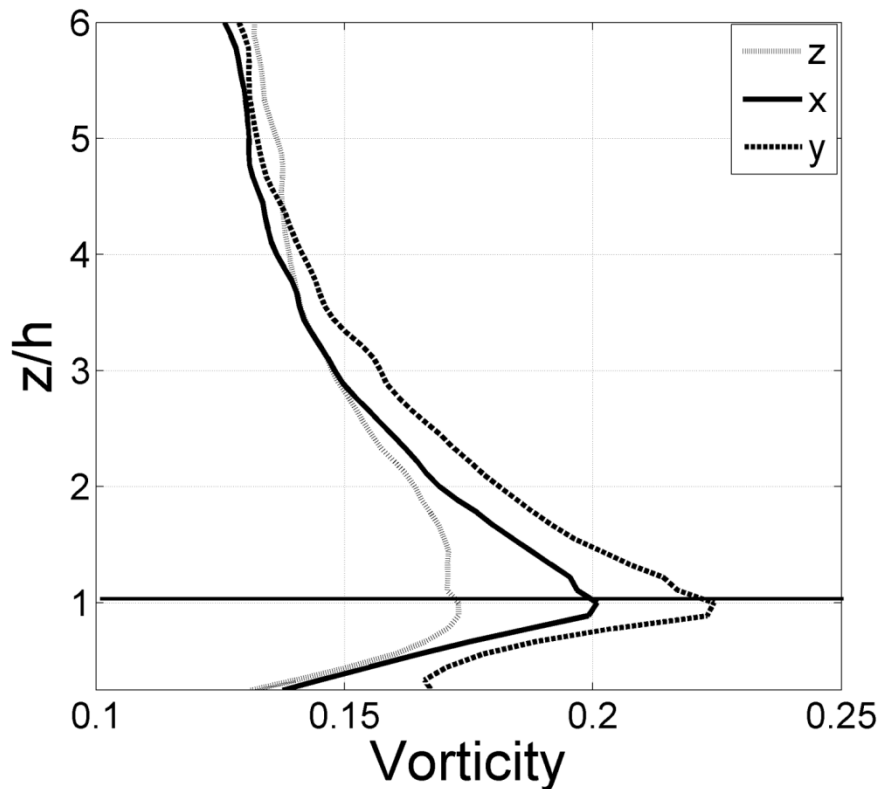

**Fig. 11** Flux ratio: momentum flux by sweep ( $w' < 0$  e  $u' > 0$ ) to that by ejection ( $w' > 0$  e  $u' < 0$ ).  
Source: Dias-Junior et al. (2015)  
(submitted to JWEIA)



# LES RESULTS

iv) the horizontal vorticity component transversal to the mean wind direction is greater than the vorticity components on the other orthogonal directions suggesting that the “roll” structures move perpendicularly to the mean wind direction.



**Fig. 12** Flux ratio: momentum flux by sweep ( $w' < 0$  e  $u' > 0$ ) to that by ejection ( $w' > 0$  e  $u' < 0$ ).  
Source: Dias-Junior et al. (2015)  
(submitted to JWEIA)

# REFERENCES

